

A series of overlapping, wavy lines in various shades of blue and grey, flowing from the left side of the page towards the right, creating a sense of movement and depth.

**Independent Hospital Pricing Authority**  
*Development of the Australian Emergency  
care classification*

**Public consultation paper – Technical compendium**

## Revision history

| Version | Date              | Modifications                             |
|---------|-------------------|---|
| 0.1     | 19 September 2017 | Initial report.                           |
| 0.2     | 21 September 2017 | Incorporation of edits from IHPA.         |
| 0.3     | 20 October 2017   | Edits for accessibility.                  |
| 0.4     | 24 October 2017   | Incorporation of edits from IHPA.         |
| 0.5     | 3 November 2017   | Incorporation of further edits from IHPA. |
|         |                   |   |
|         |                   |   |
|         |                   |   |

## Suggested citation

Health Policy Analysis 2017, *Development of the Australian Emergency care classification - Public consultation paper – Technical compendium*, Independent Hospital Pricing Authority, Sydney.

## Disclaimer

In accordance with Health Policy Analysis' policy, we are obliged to advise that neither Health Policy Analysis nor any employee nor sub-contractor undertakes responsibility in any way whatsoever to any person or organisation (other than the Independent Hospital Pricing Authority) in respect of information set out in this report, including any errors or omissions therein, arising through negligence or otherwise however caused.

## Health Policy Analysis Pty Ltd

Suite 101, 30 Atchison Street, St Leonards 2065

ABN: 54 105 830 920

Phone: +61 2 8065 6491

Fax: +61 2 8905 9151



# Table of contents

|   |    |
|---|----|
| 1. Introduction.....                              | 4  |
| Overview of AECC .....                            | 4  |
| Document structure.....                           | 5  |
| 2. Regression trees .....                         | 6  |
| 3. AECC grouping logic .....                      | 33 |
| 4. AECC end class costs and cost dispersion.....  | 43 |
| 5. Indicative national volumes by end class ..... | 54 |
| 6. Mapping of ICD-10-AM short list to ECDGs.....  | 59 |

# Introduction



This is a technical compendium to the *Public consultation paper* for the Australian Emergency Care Classification (AECC). The *Public consultation paper* seeks stakeholders' views on the proposed classification. This document contains further information on the classification end classes and the grouping logic, to assist stakeholders in the review of the proposed classification.

## Overview of AECC

The proposed AECC is shown in Figure 1:

- The first level groups emergency stays into those requiring emergency care and a small set of other classes, some with no further splits.
- The second level groups emergency stays into clinically meaningful groups using emergency department diagnosis. The groupings of emergency department diagnoses are referred to as 'emergency care diagnosis groups' (ECDGs).
- Where required, the third level splits the ECDGs to reflect different levels of severity and/or complexity (consequently also reflecting resource use).

Figure 1 – Overview of AECC

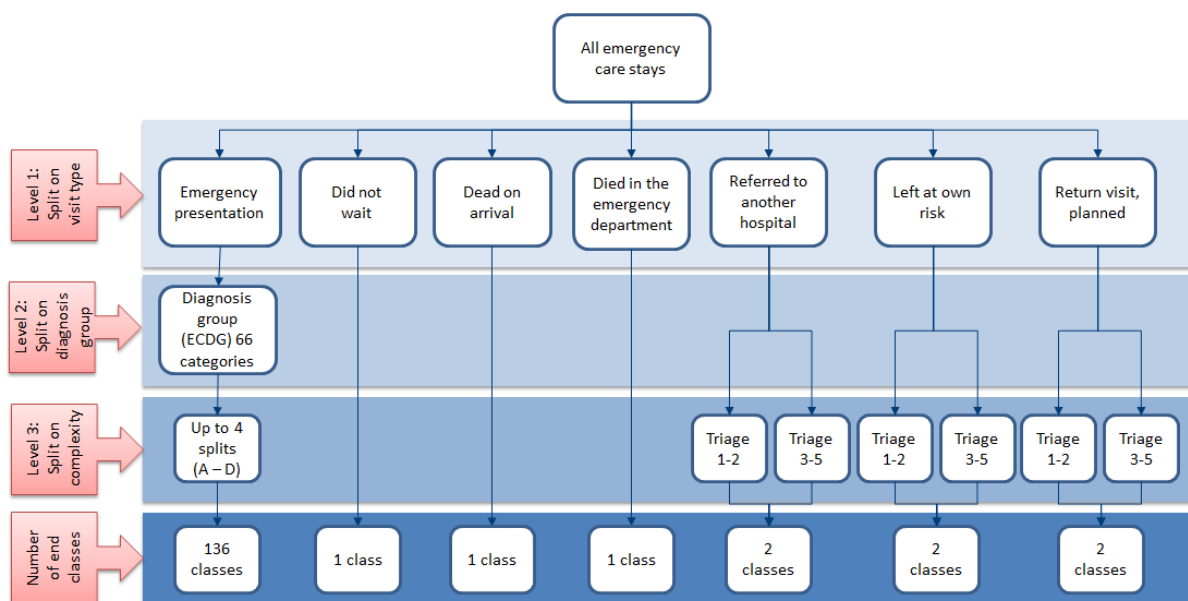

The proposed classification has 145 end classes.

## Document structure

This document contains the following information to assist with providing feedback on the draft AECC:

- **Chapter 2:** Regression trees – shows the grouping logic of the draft AECC classes diagrammatically.
- **Chapter 3:** AECC grouping logic – shows the grouping logic of the draft AECC classes in text form.
- **Chapter 4:** AECC end class costs and cost dispersion – shows a table of the average costs by end class, and box plots of the dispersion of costs of the stays within each draft AECC end class. The data is from the *Emergency care costing study*.
- **Chapter 5:** Indicative national volumes for end classes – shows the number of stays assigned to each draft AECC end class using data from the National Hospital Cost Data Collection (NHCDC) for 2014-15.
- **Chapter 6:** Mapping the IHPA ICD-10-AM short list to ECDGs – shows IHPA's Emergency department ICD-10-AM (9th edition) principal diagnosis short list mapped to the proposed ECDGs.

# Regression trees

This Chapter shows the AECC grouping logic diagrammatically, as regression trees.

In the trees, the 'Yes' and 'No' branches have only been labelled at the top level. Where a tree branches out further, 'Yes' is always to the left, and 'No' to the right.

The regression trees below and grouping logic shown in the next Chapter use shorthand to refer to variables used in the draft classification and values within those variables. A key for these is in the table below. Age groups are not included in the table as they are adequately labelled in the regression trees and grouping logic table.

| Variable name | Description                                      | Values   |
|---------------|--|--|
| Edtriag       | Triage (urgency)                                 | 1 = Resuscitation<br>2 = Emergency<br>3 = Urgent<br>4 = Semi-urgent<br>5 = Non-urgent  |
| Edtriag2      | Triage (urgency) collapsed categories            | 1_2 = Resuscitation or Emergency<br>3 = Urgent<br>Other = Semi-urgent or Non-urgent  |
| Transmode2    | Transport mode                                   | 1 = Ambulance, air/helicopter<br>2 = Police/corrections<br>8 = Other<br>9 = Not stated/unknown   |
| Transmode3    | Transport mode collapsed categories              | 1 = Ambulance, air/helicopter<br>Other = all other   |
| Eddepst       | Episode end status                               | 1 = Admitted<br>2 = Departed<br>3 = Ref. to another hosp<br>4 = Did not wait<br>5 = Left at own risk<br>6 = Died in ED<br>7 = Dead on arrival  |
| Eddepst2      | Episode end status collapsed categories          | 1_3_6 = Admitted or Ref. to another hosp or Died in ED<br>2 = Departed<br>5 = Left at own risk<br>Other = Did not wait or Dead on arrival  |
| A, B, C, D    | End class representing complexity / resource use | Values represent complexity / resource use of end classes with A representing the highest cost, and D representing the lowest cost.<br><br>Note, where there is only one resulting end class, this has been labelled A, in the interim, despite there being no differentiation in complexity for the ECDG. |

### B63 Dementia / chronic brain syndrome

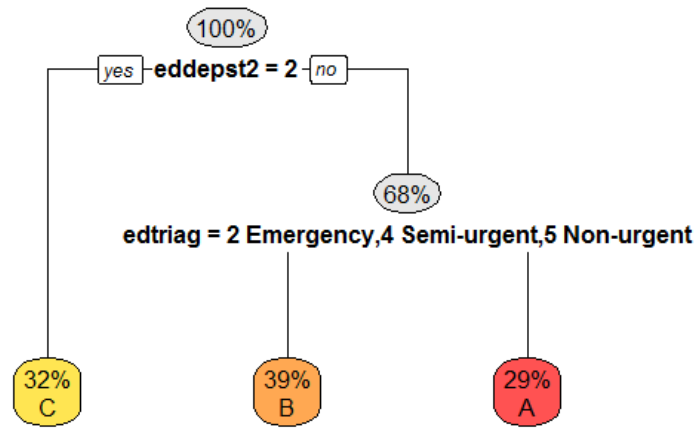

### B70 Stroke & other cerebrovascular disorders

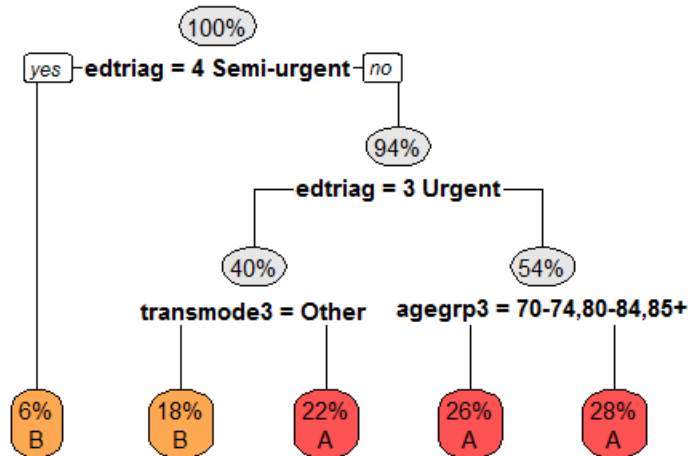

### B81 Disorders of the nervous system, other

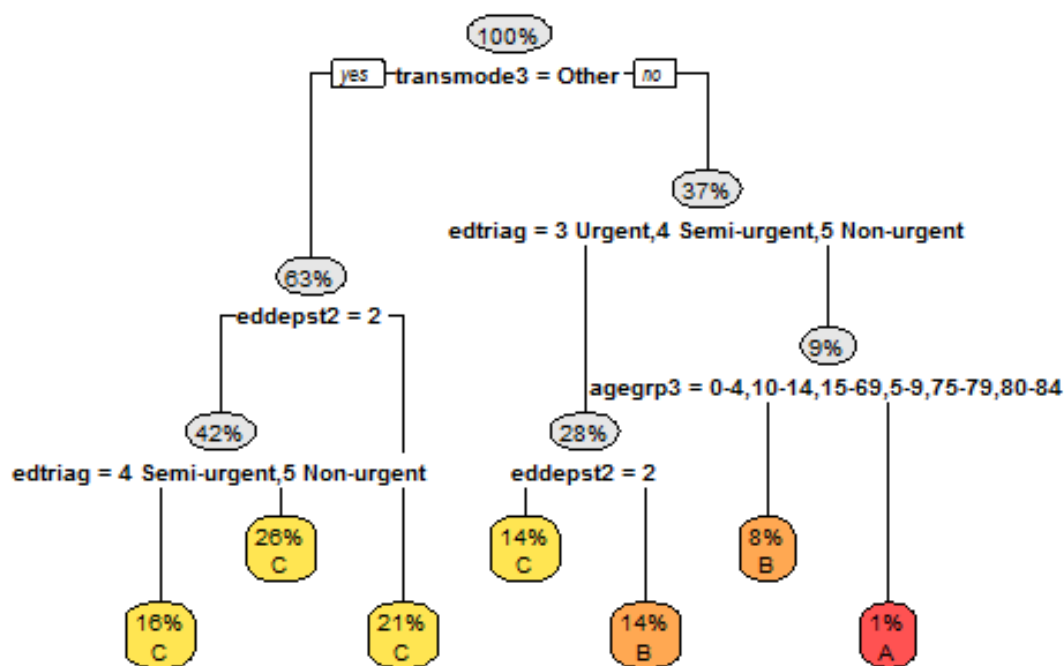

### C633 Eye disorder, other

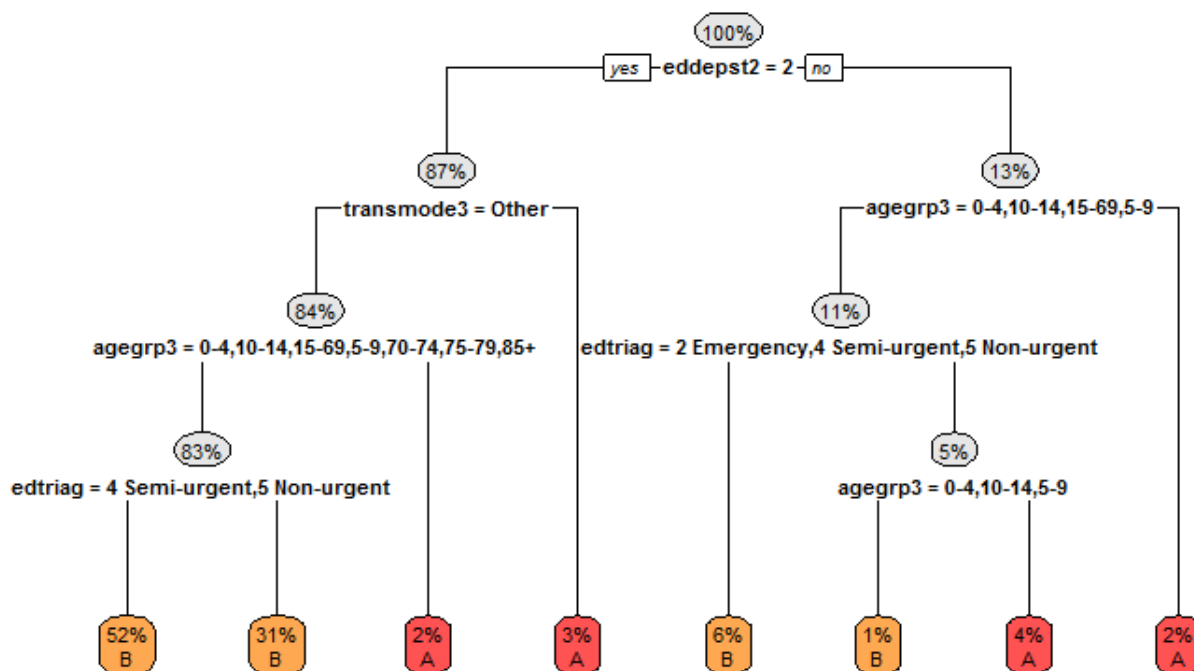



### D66 Ear, nose, mouth and throat disorders, other

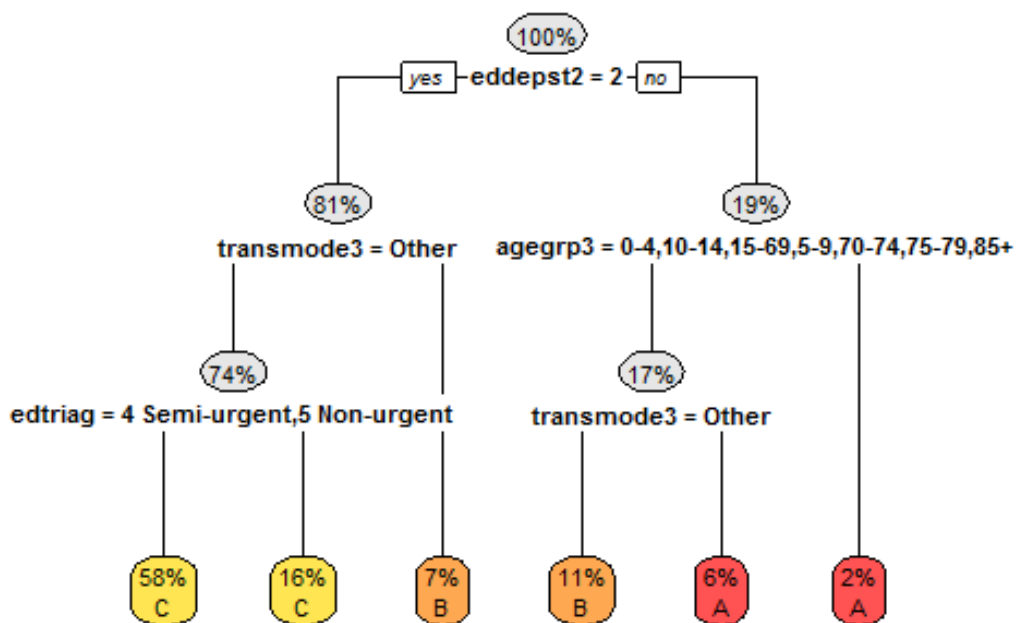

### D671 Teeth and supporting structures disorders, other

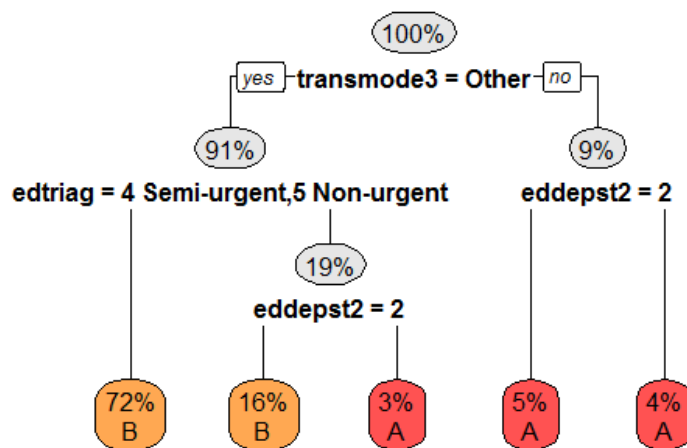

### E61 Major respiratory diagnosis

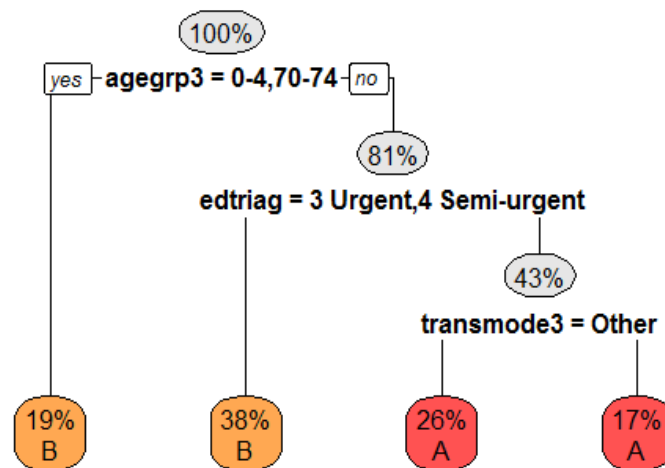

### E623 Upper respiratory tract infection (URTI), other

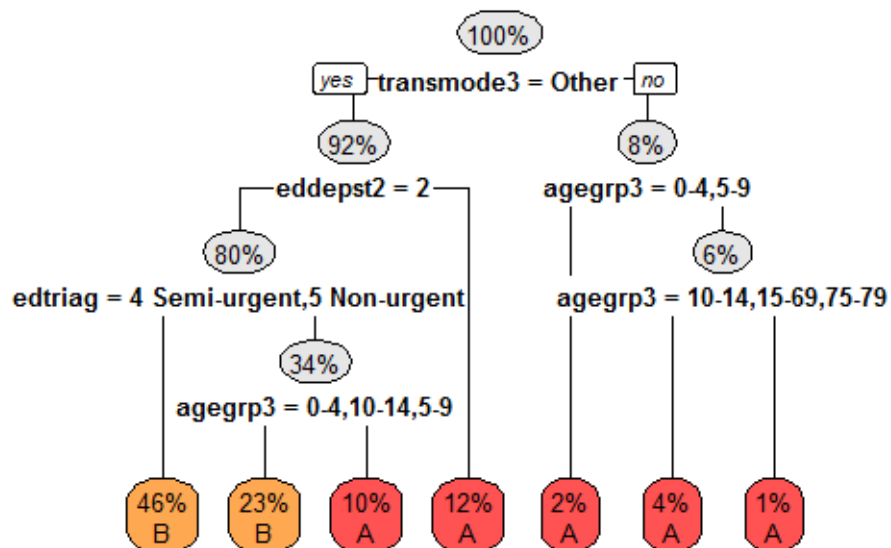

### E69 Asthma/ wheeze/ croup/ airway infection

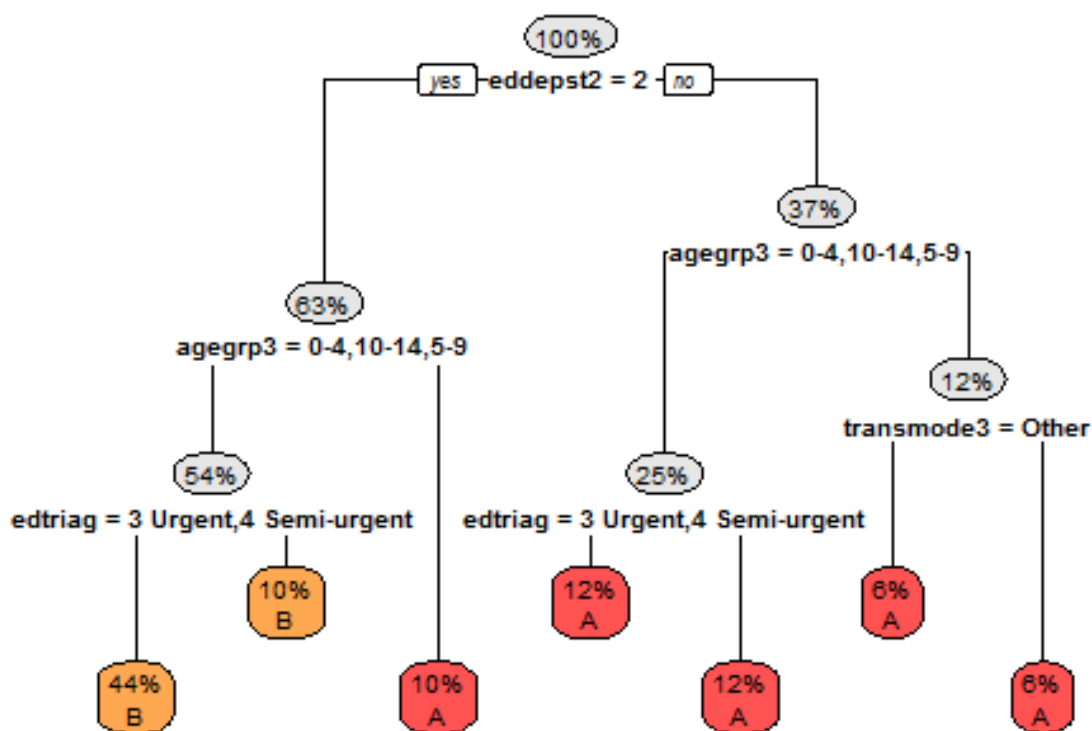

### E753 Respiratory disorder, other

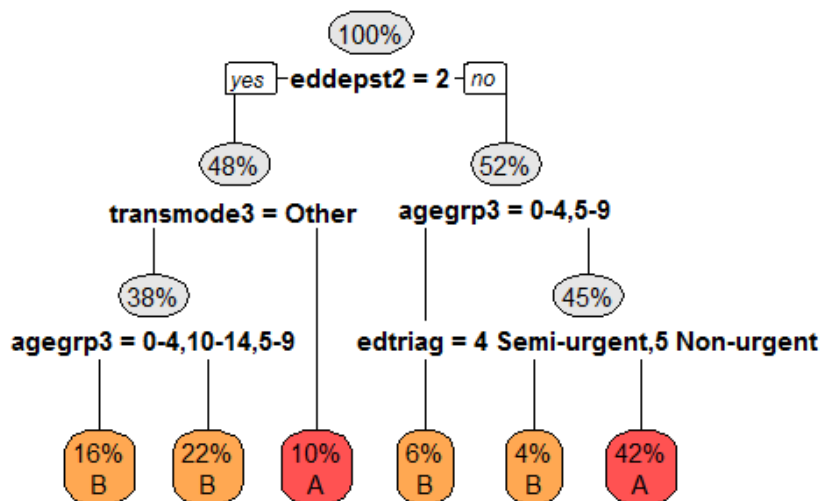

### F62 Heart failure and shock

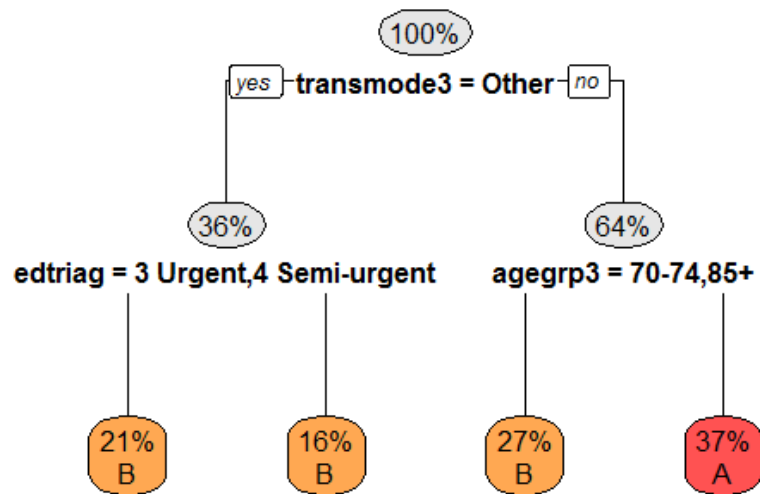

### F74 Chest pain

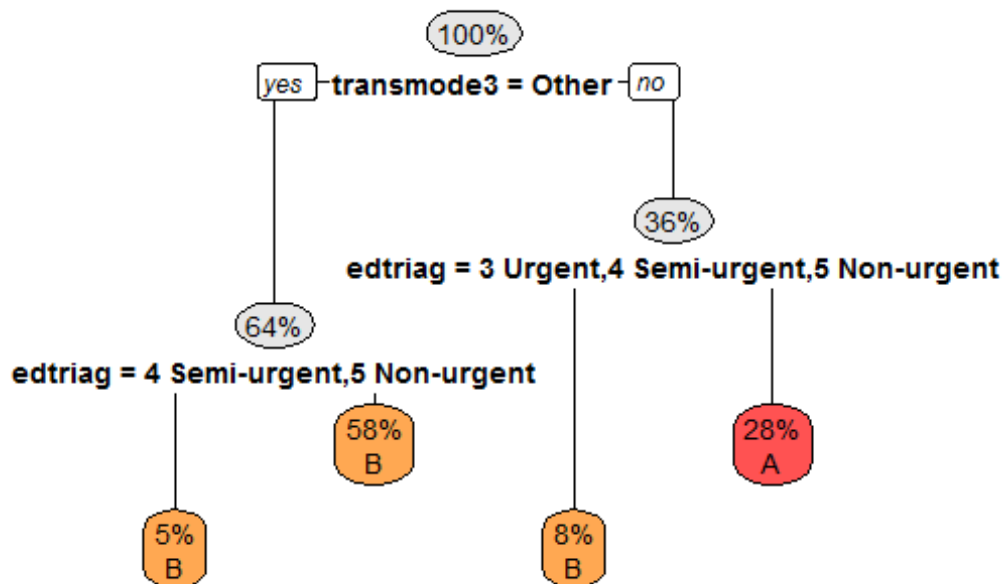

### F75 Circulatory disorder, other

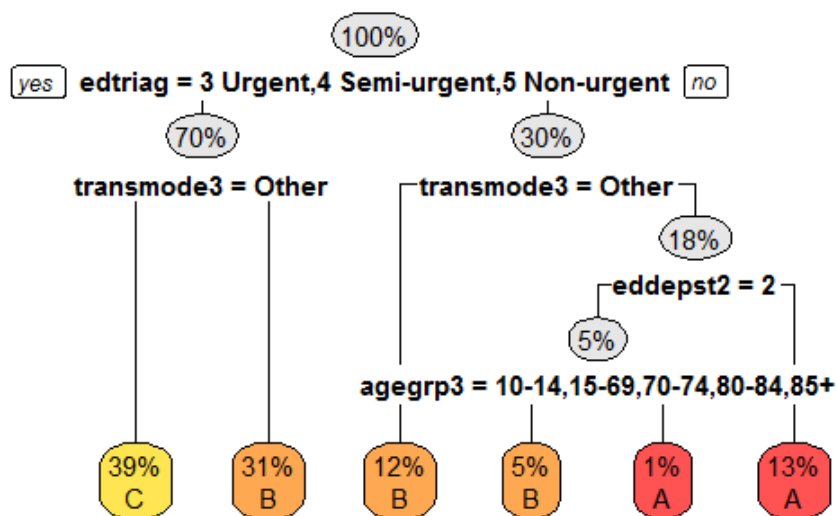

### F76 Arrhythmia and cardiac arrest

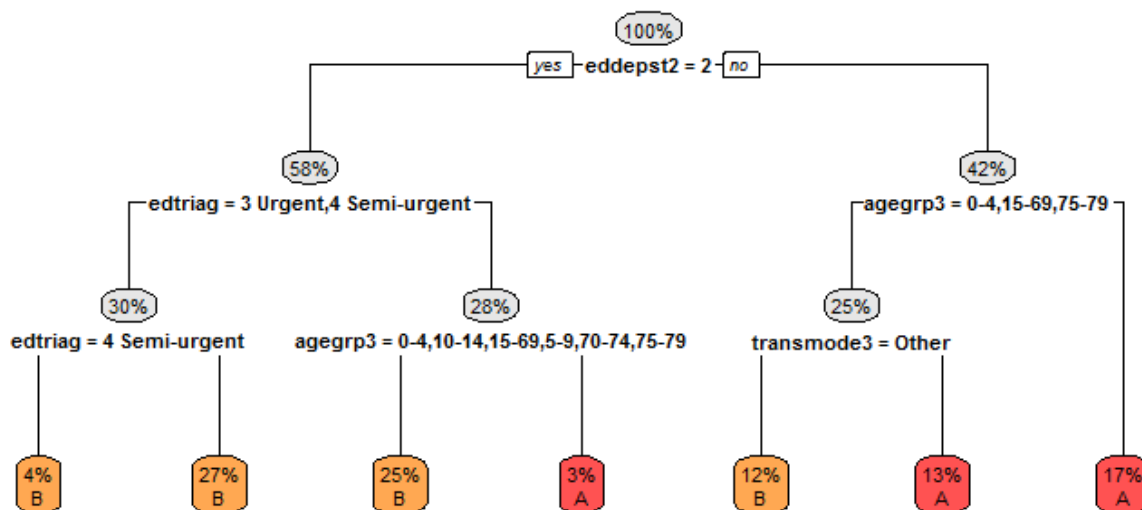

### G61 Gastrointestinal haemorrhage

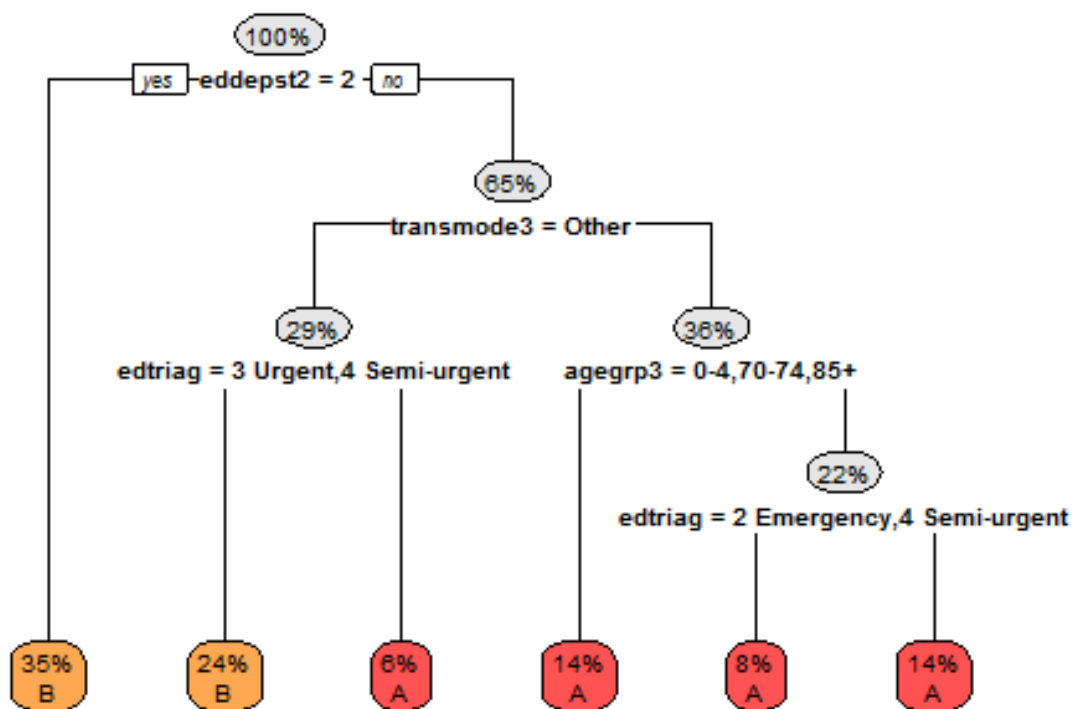

### G661 Gastrointestinal peritonitis/ perforation

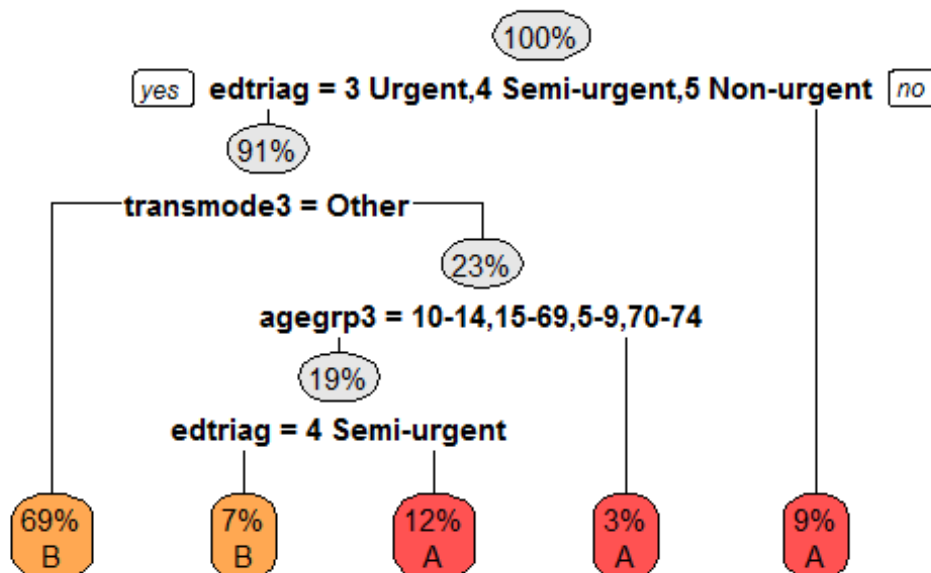

### G662 Abdominal pain

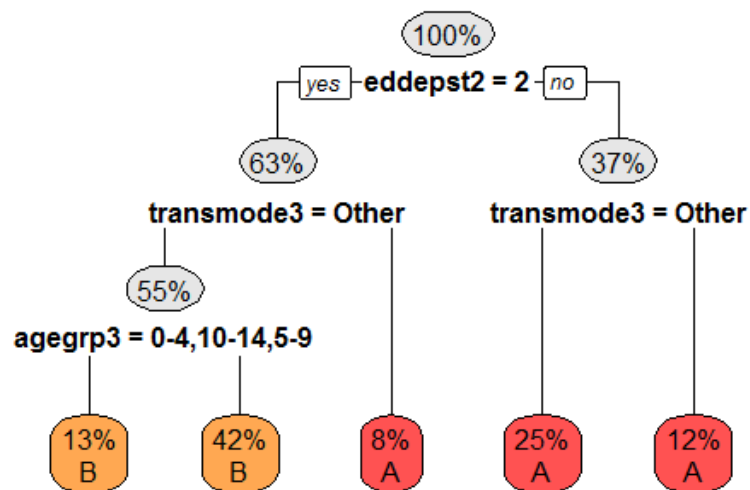

### G67 Oesophagitis and gastroenteritis

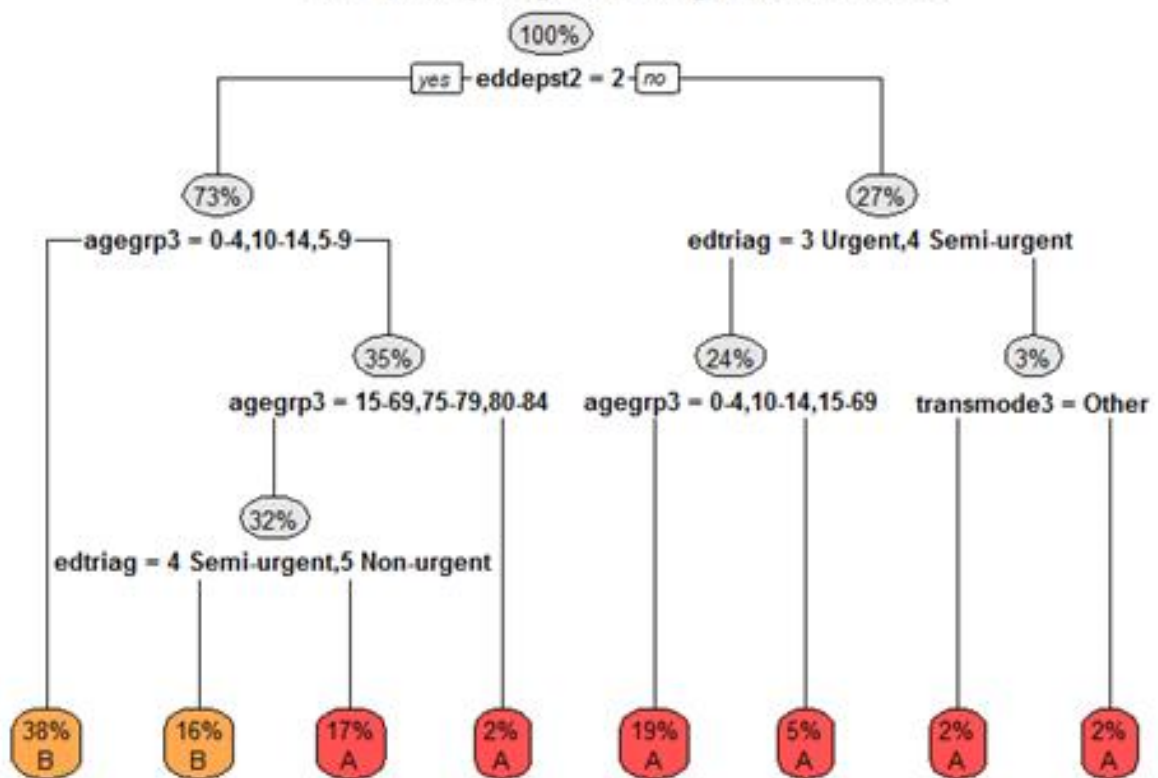

### G702 Digestive system disorders, other

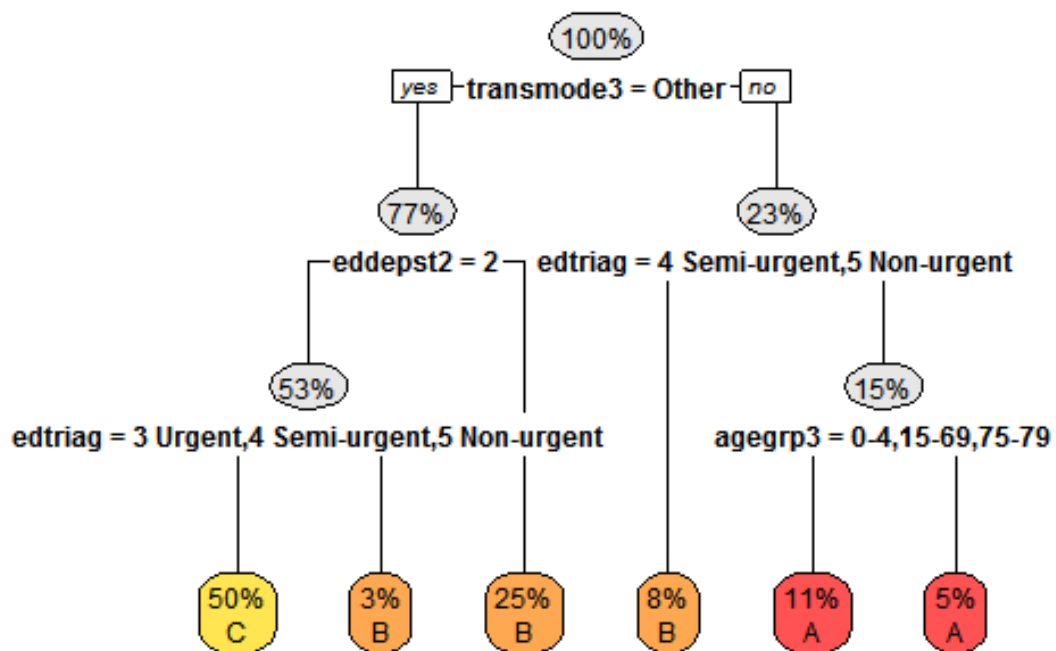

### H63 Disorders of liver

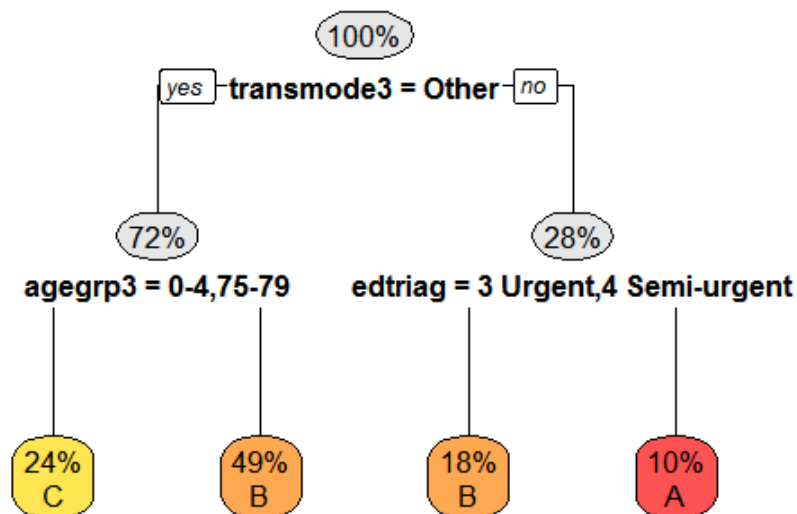



### H64 Disorder of the biliary tract

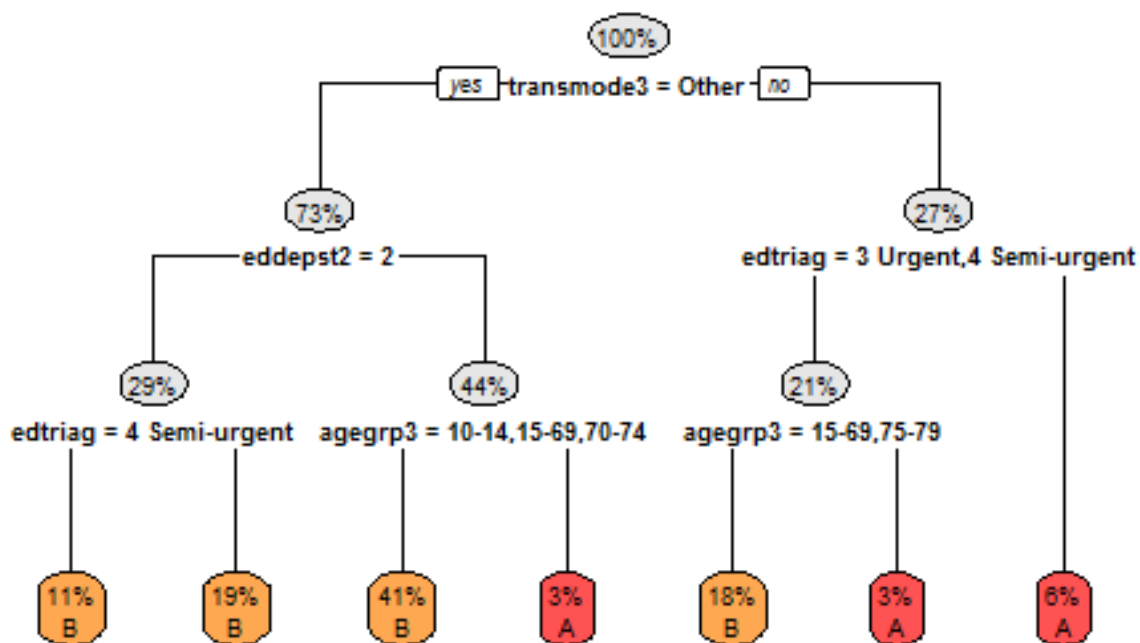

### I01 Major injury

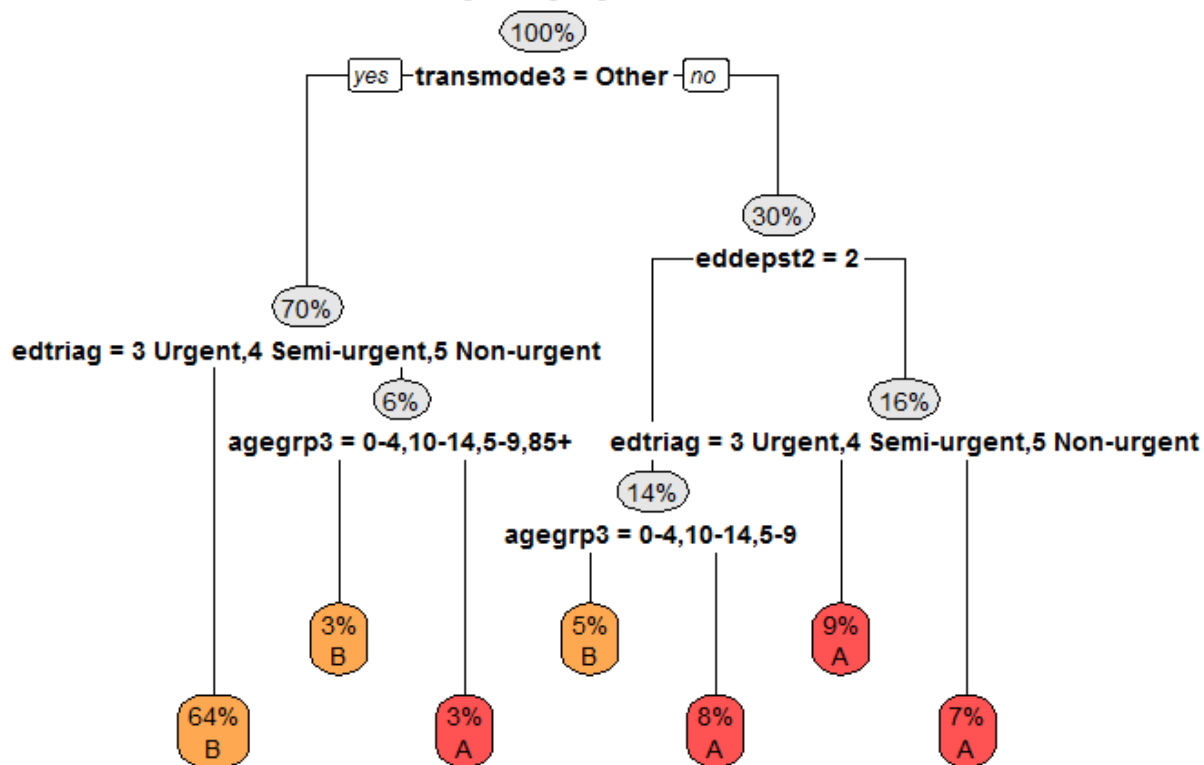

### I02 Fractures of neck of femur

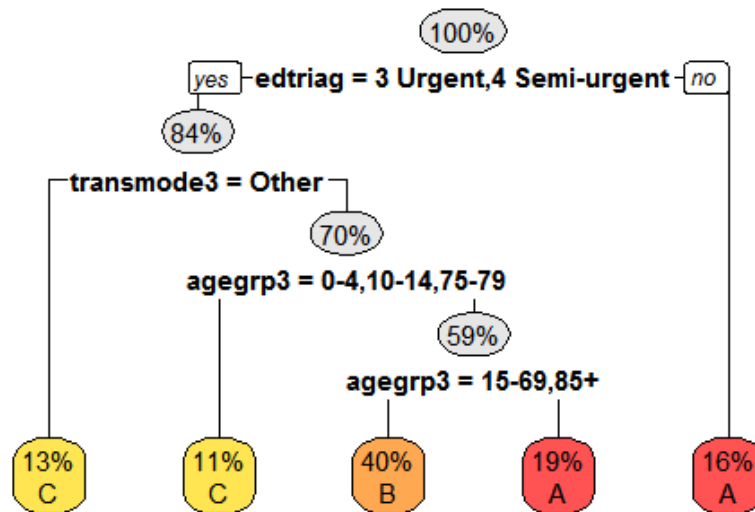

### I03 Fracture of shoulder and lower leg, dislocation, sprain and strain

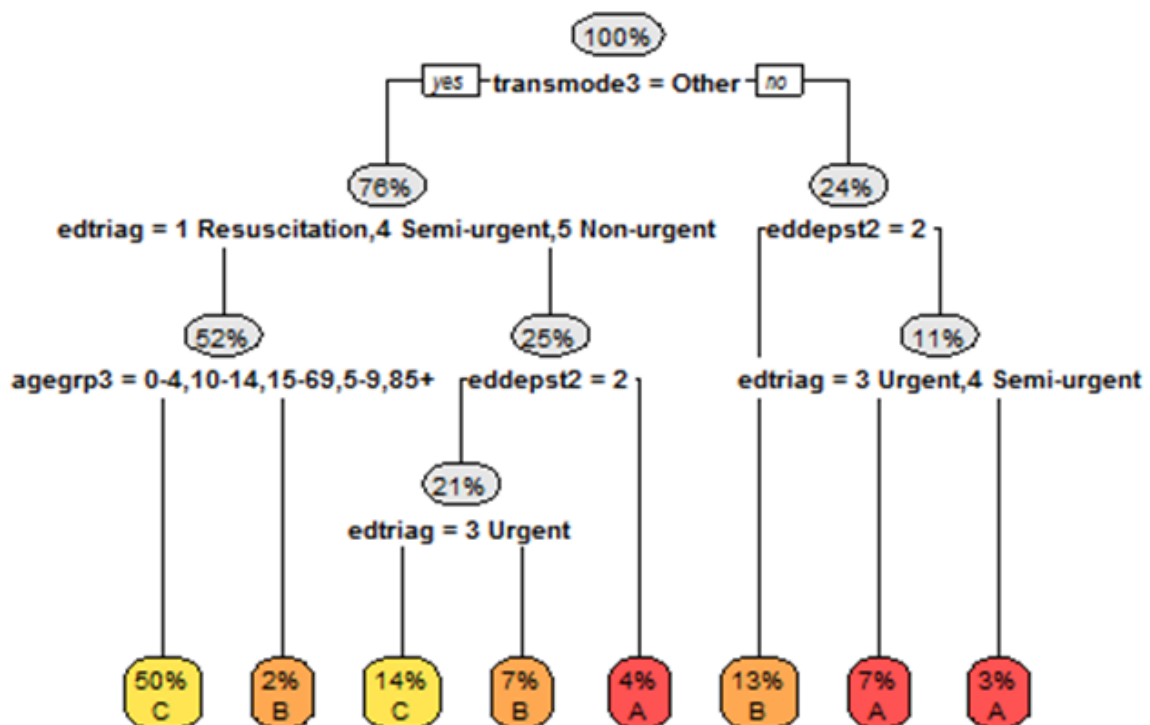

### I04 Injuries, fractures (forearm, wrist, ankle, foot), and other injuries

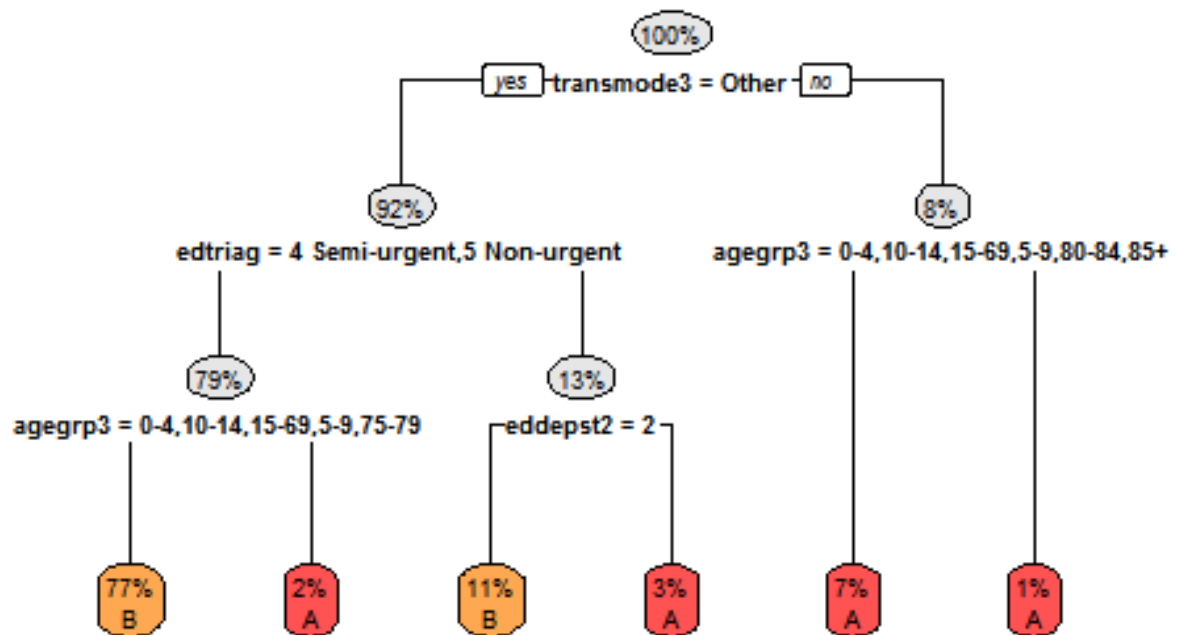

### I05 Injury, other

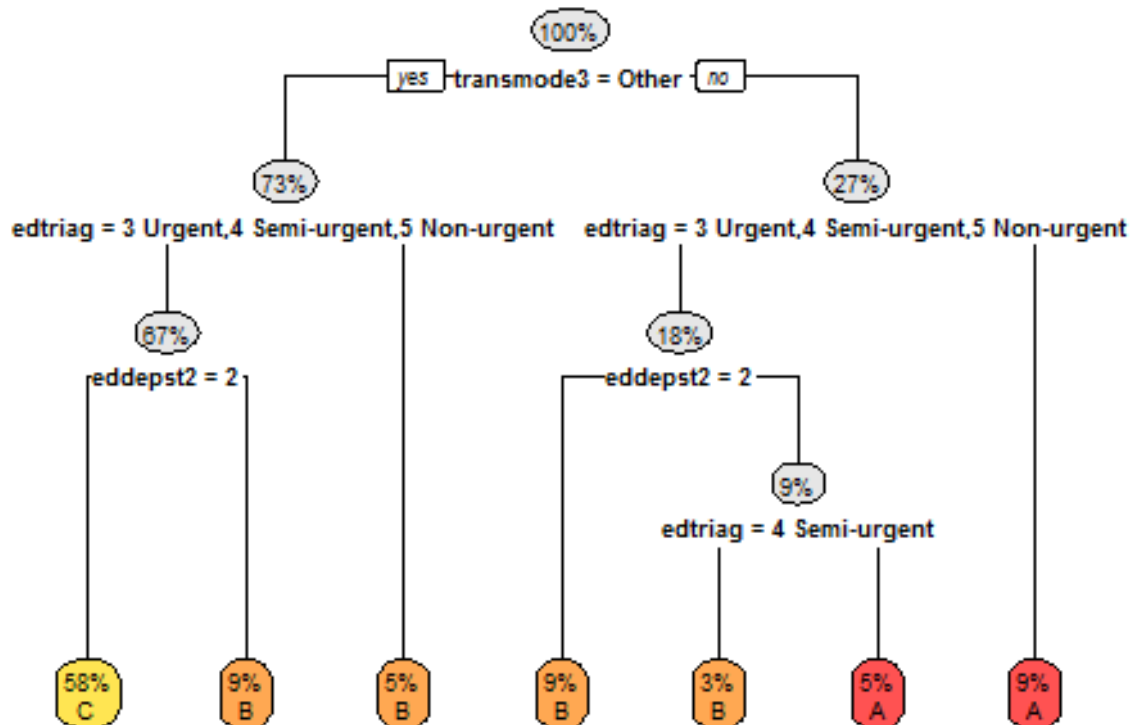

### I06 Minor injury

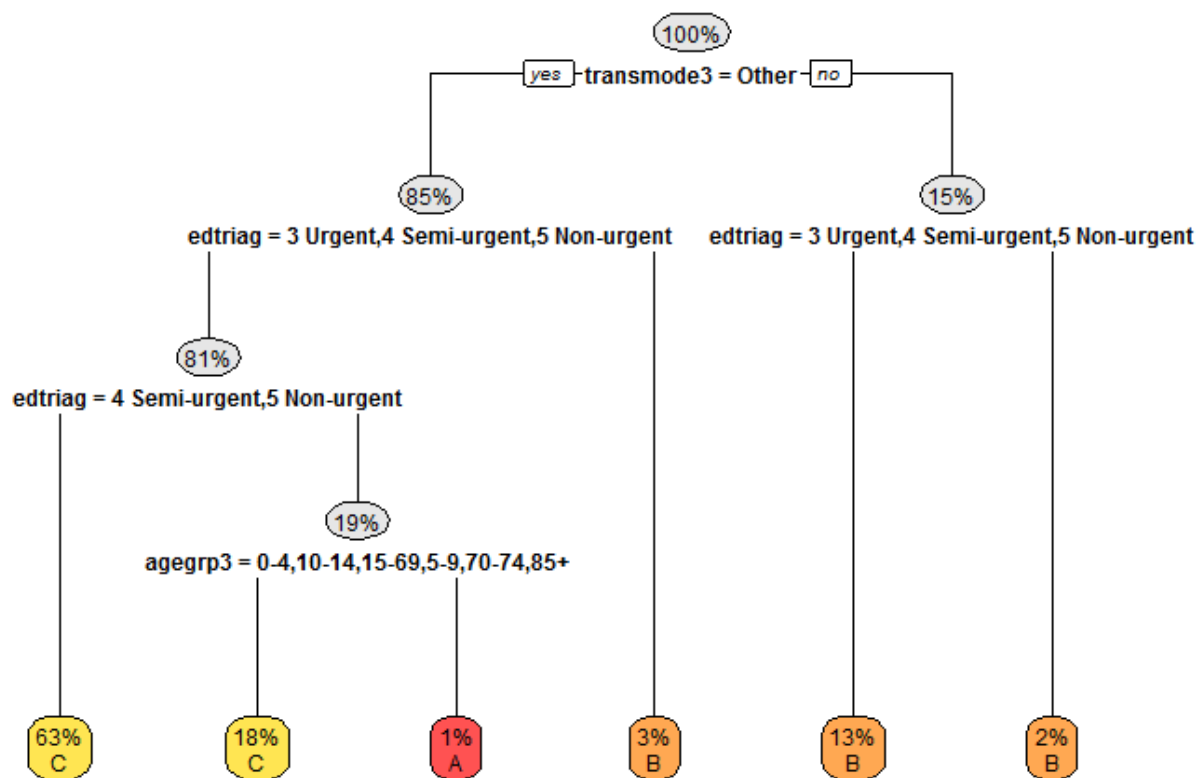

### I71 Musculotendinous disorders, other

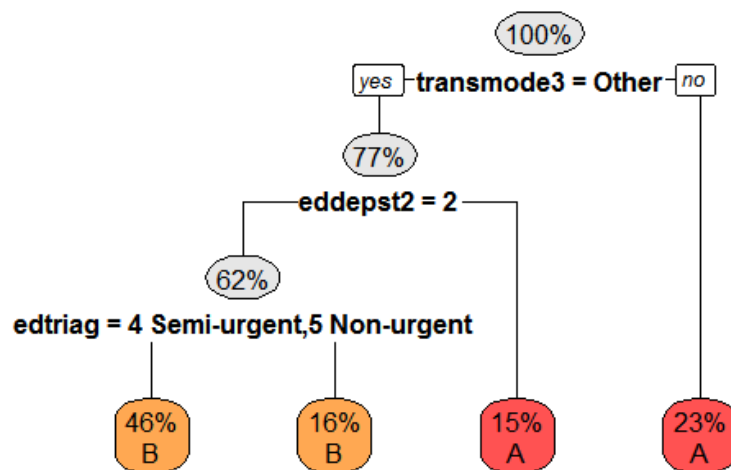

### 185 Complications of surgical and medical care

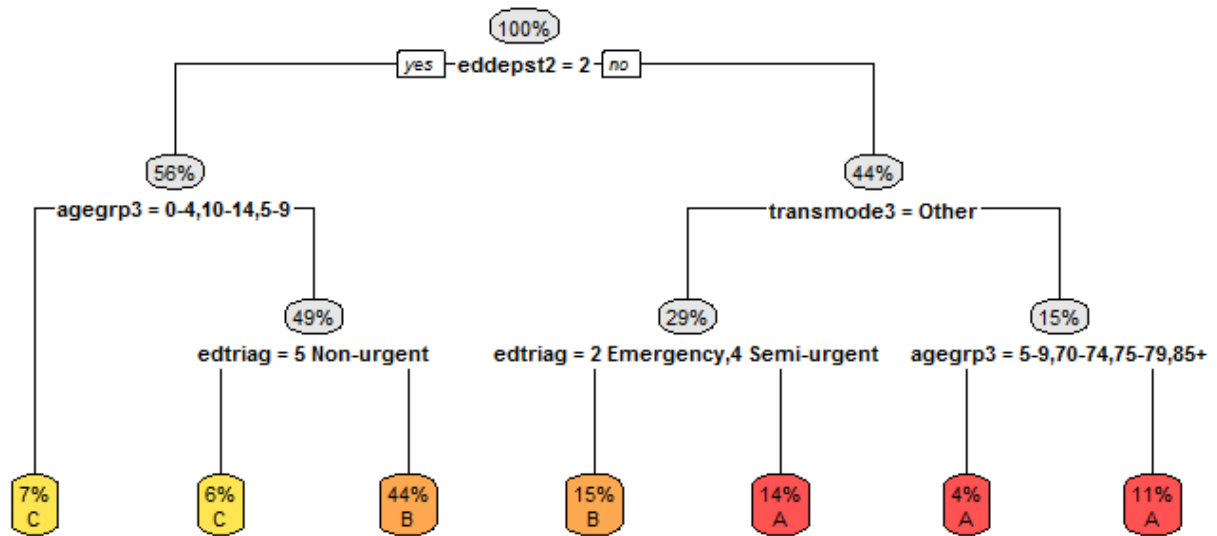

### J64 Cellulitis/ skin infection

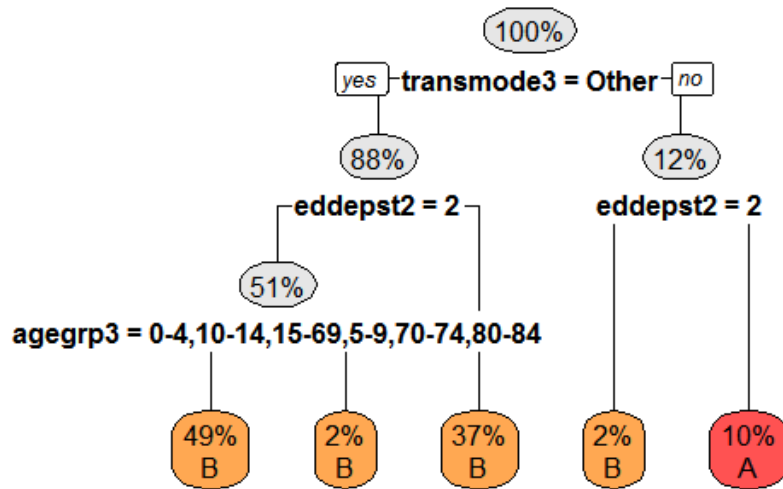

### J67 Skin disorders, other

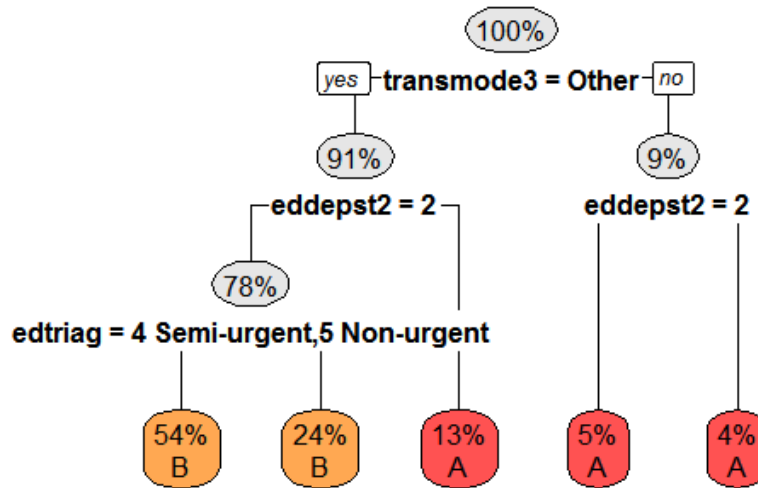

### K60 Diabetes

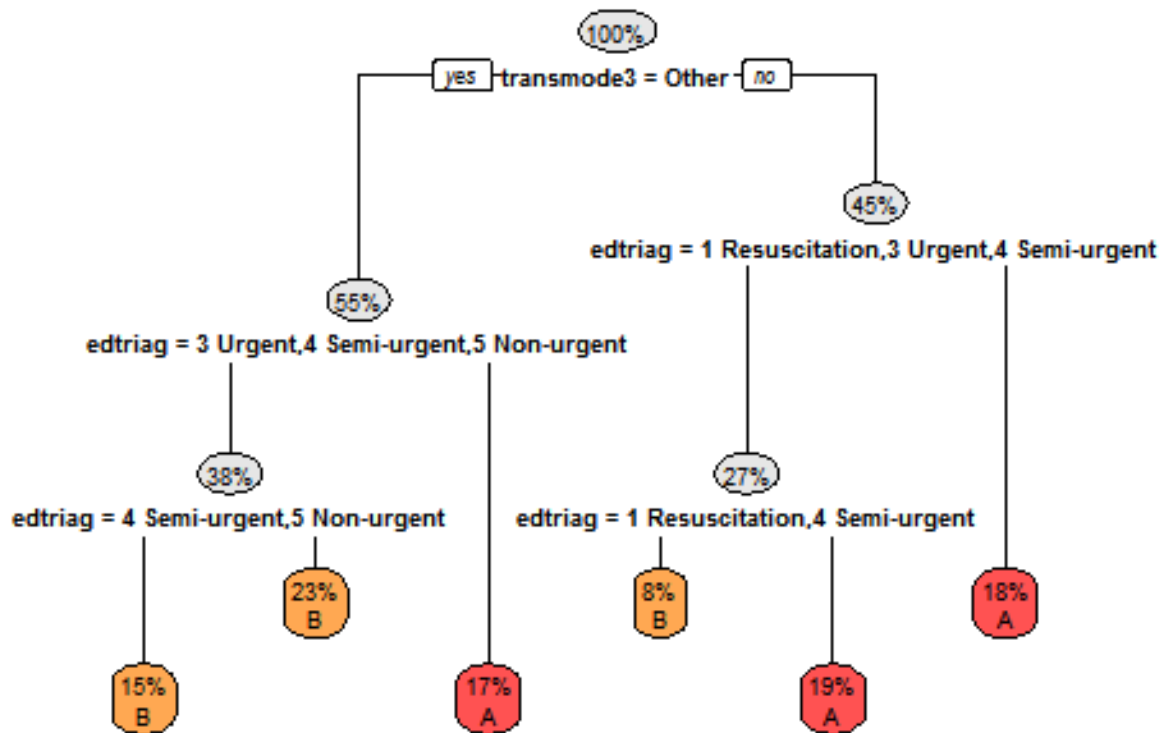

### K62 Miscellaneous metabolic disorders

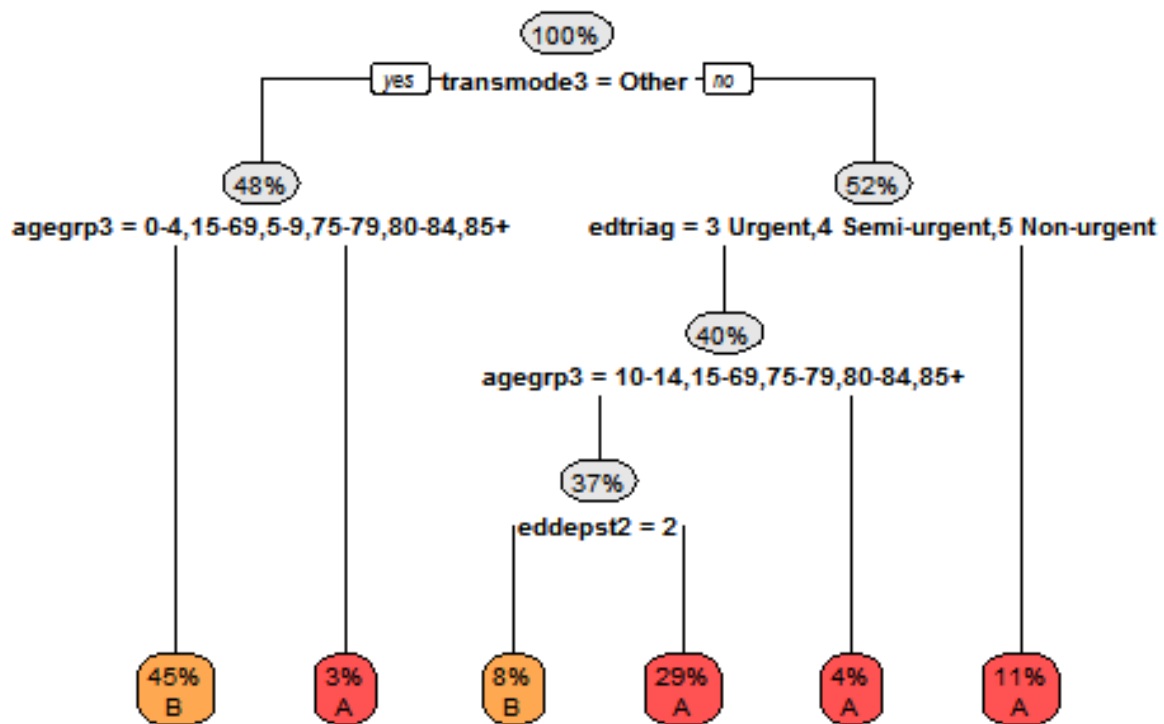

### L60 Renal failure

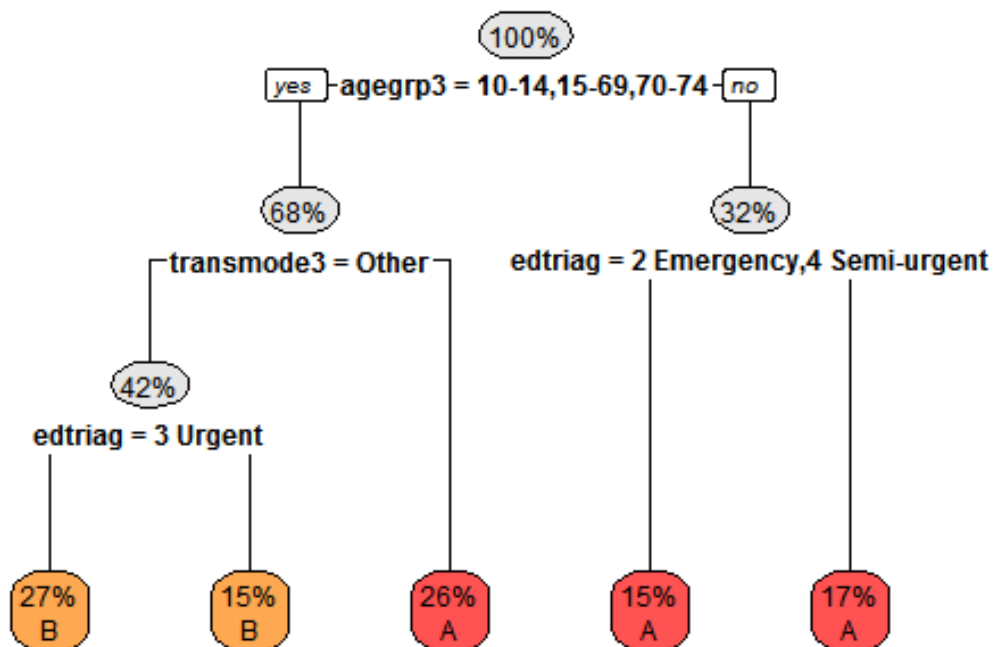

### L672 Kidney and urinary tract disorder, other

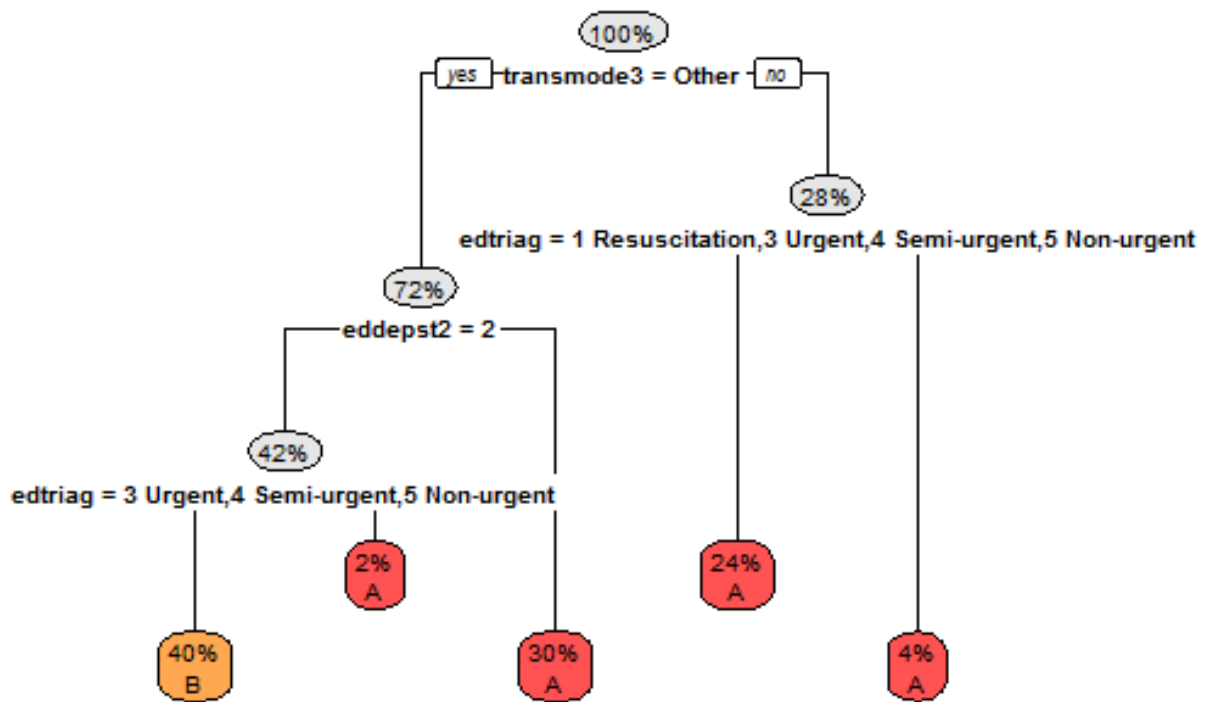

### P68 Perinatal disorders

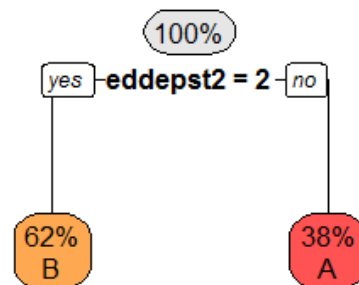



### Q60 Reticuloendothelial and immunity disorder

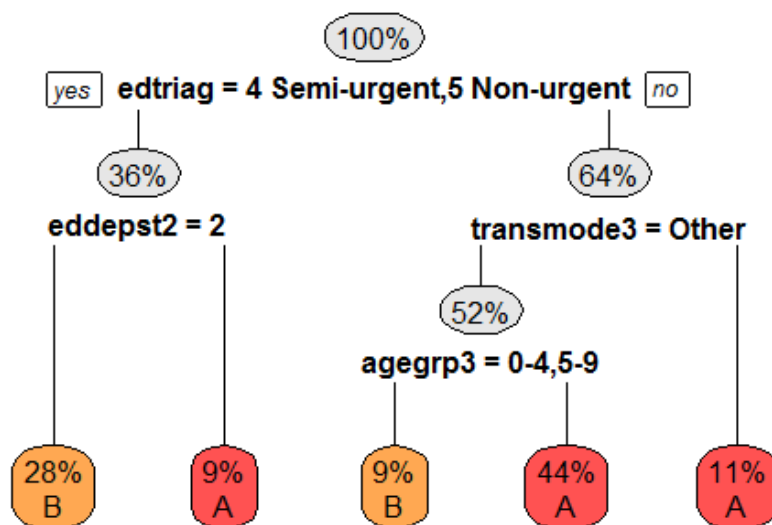

### Q61 Red blood cell disorders

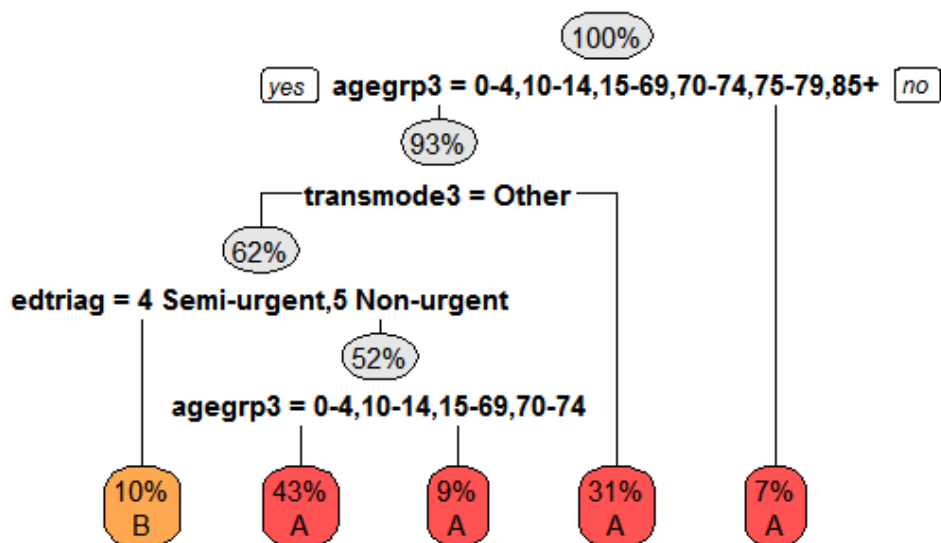

### Q62 Haemostasis

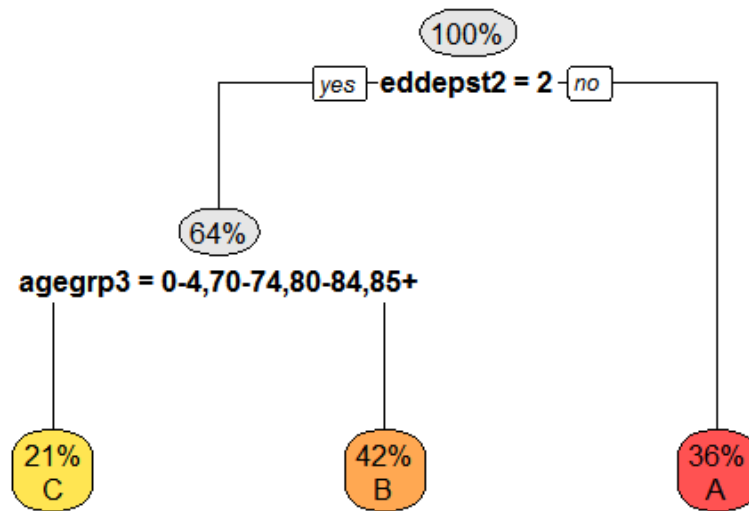

### R62 Neoplastic disorders

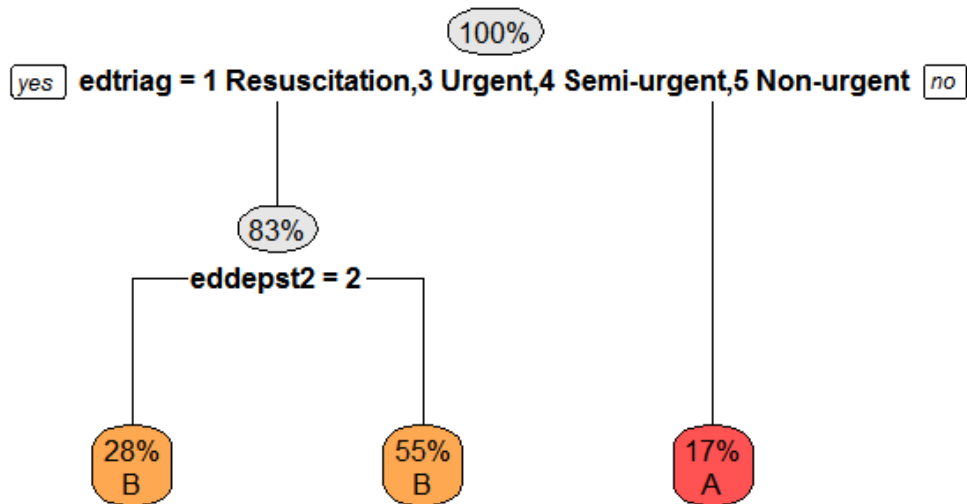

### T60 Septicaemia

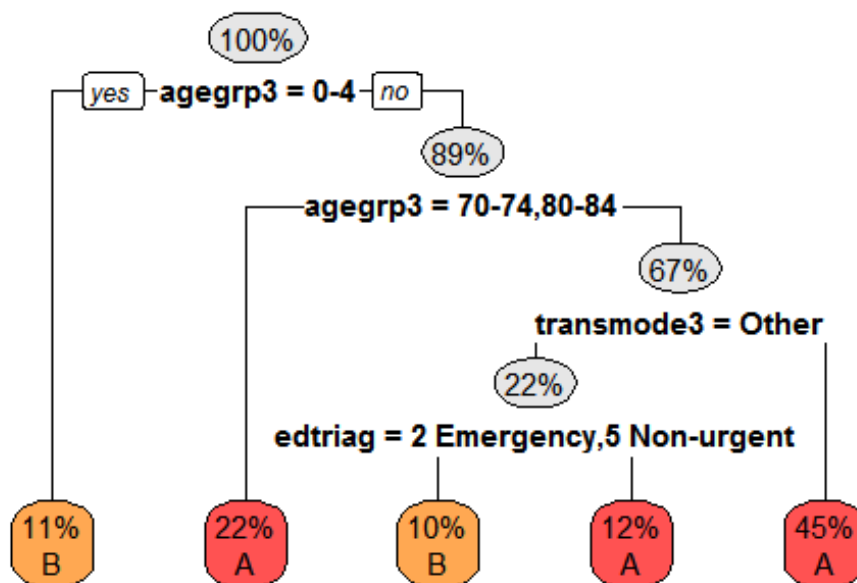

### T62 Fever of unknown origin

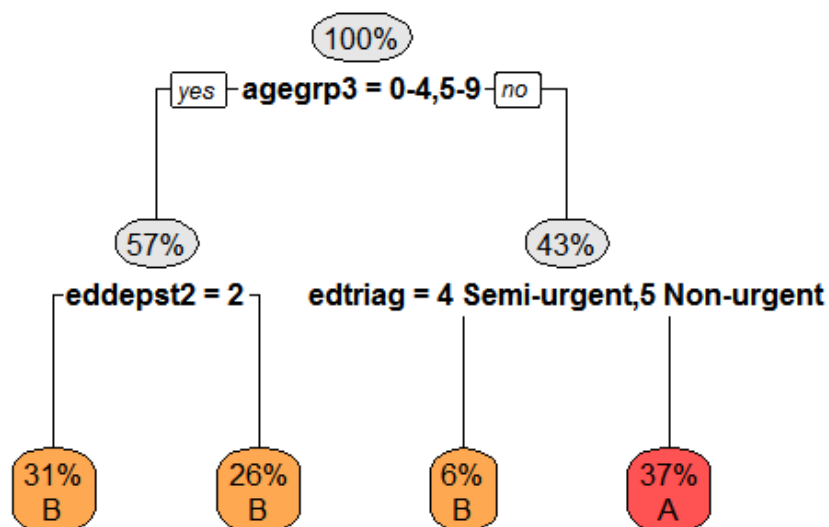

### T63 Viral illness

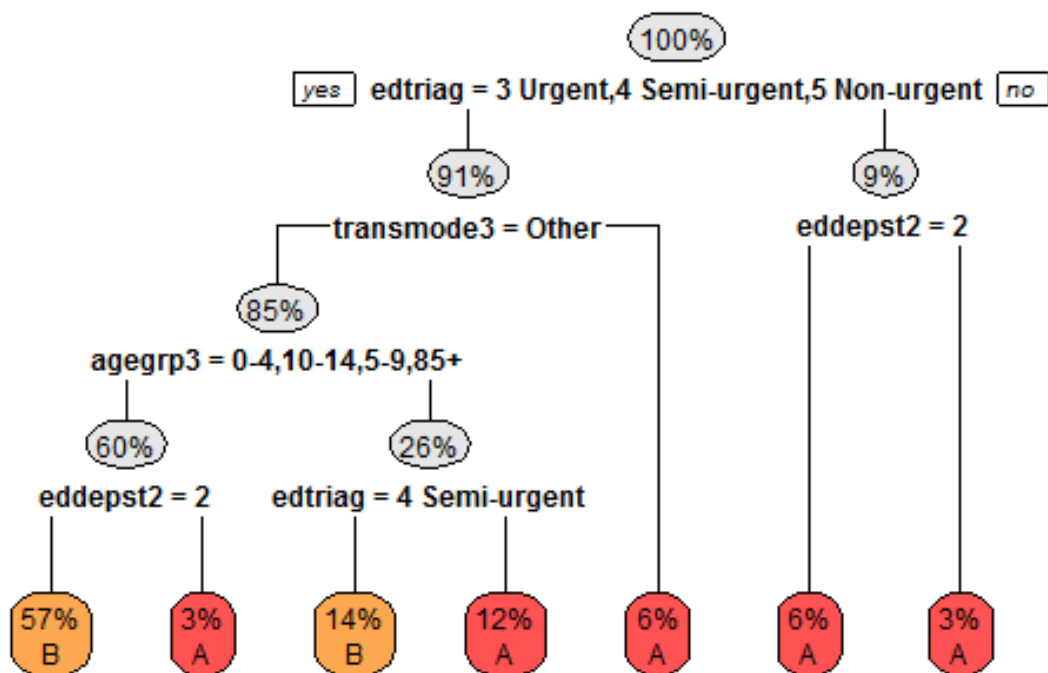

### T64 Infectious and parasitic disease, other

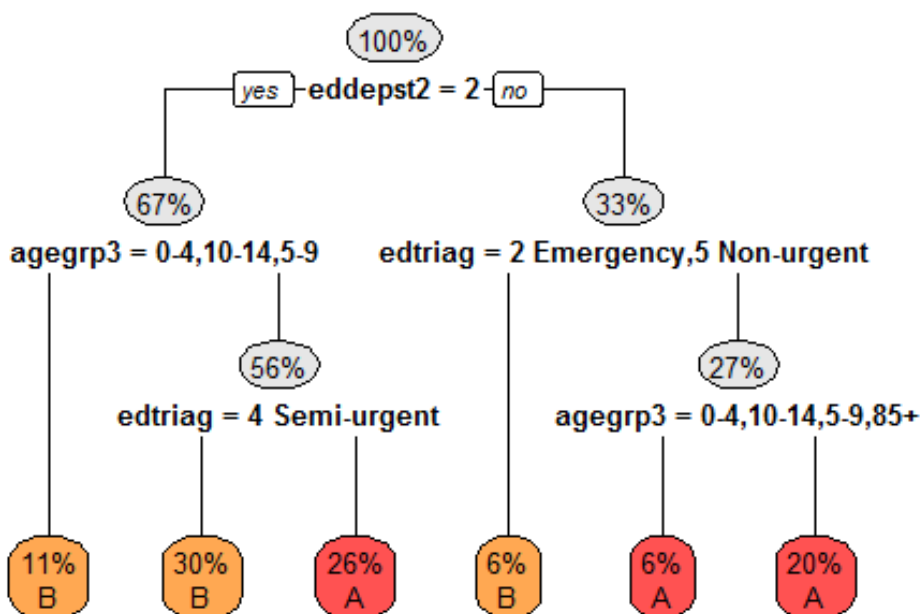

### U62 Psychosis

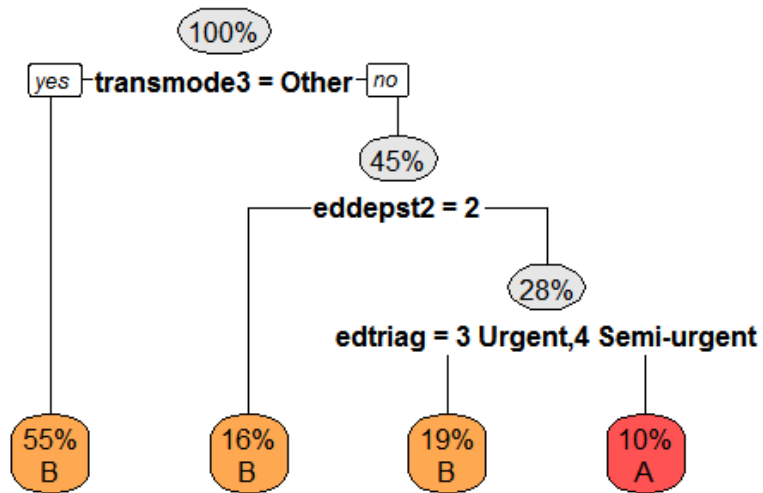

### U69 Mental and behavioural disorder, other

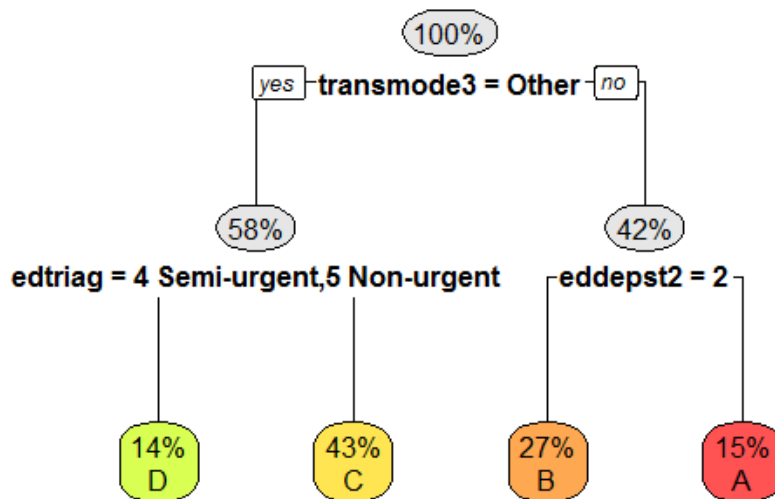

### V69 Alcohol and/ or drug related mental and behavioural disorders

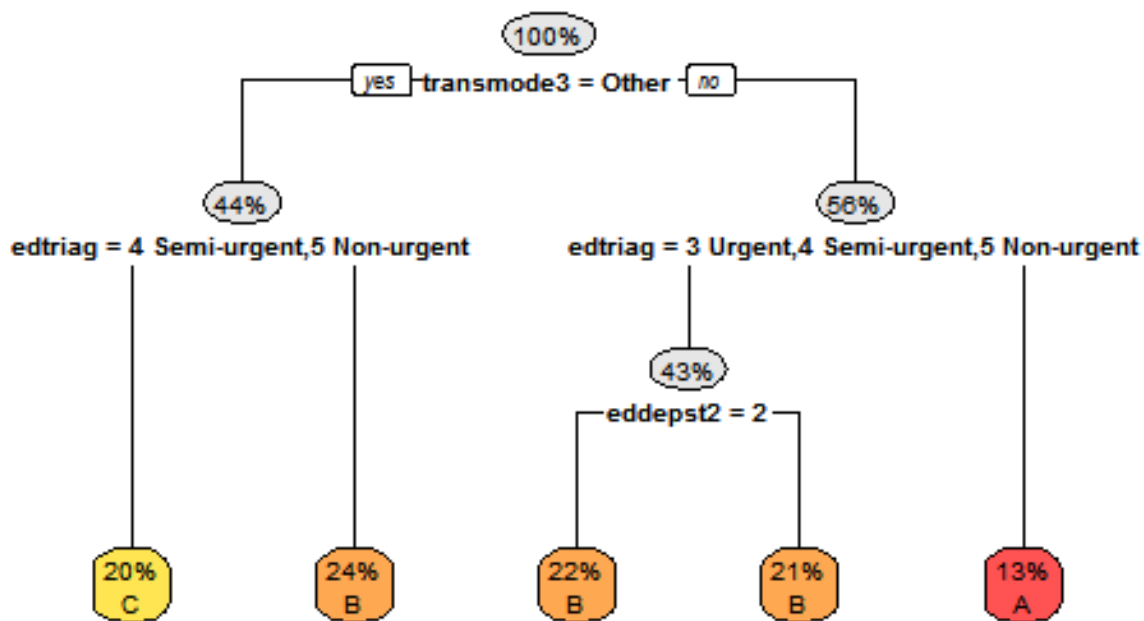

### X61 Allergic reactions

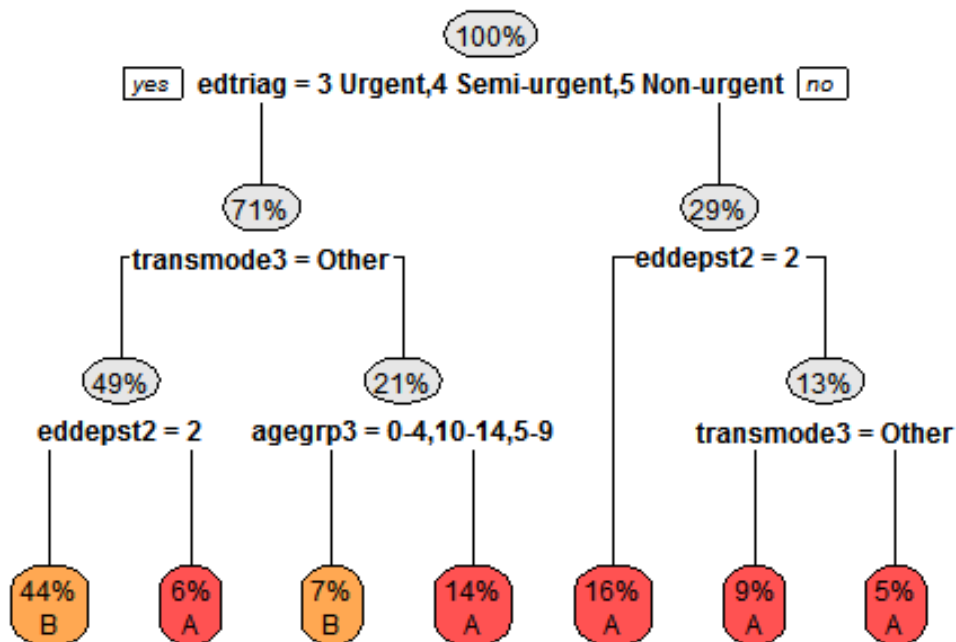

### X62 Poisoning

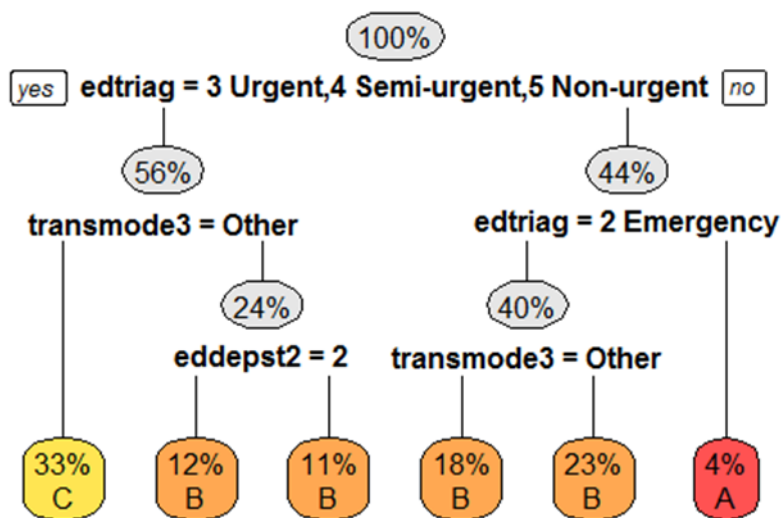

### X64 Abuse and neglect

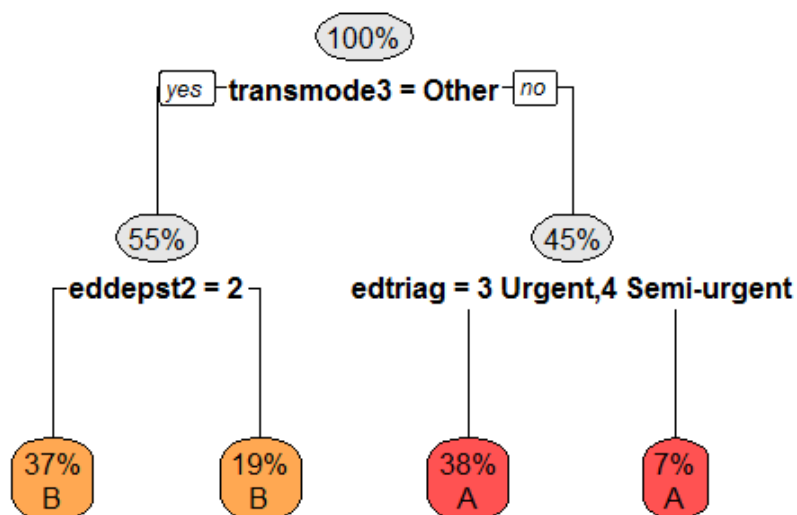

### Y62 Burns

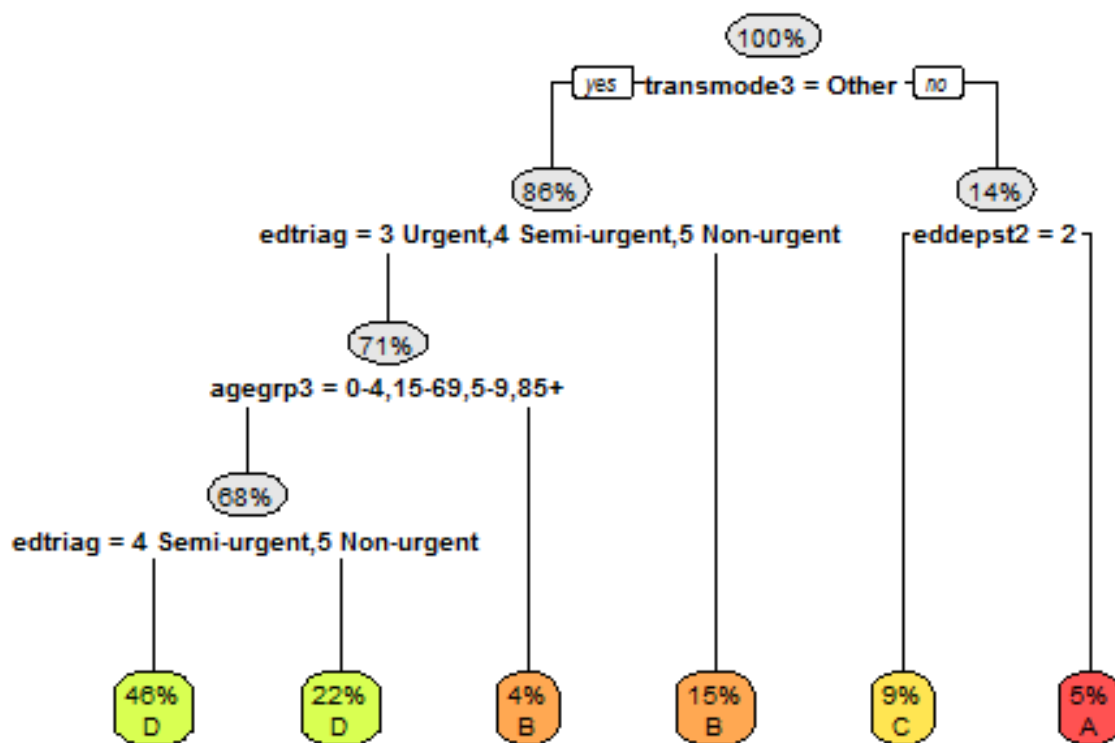

### Z64 Other factors influencing health status

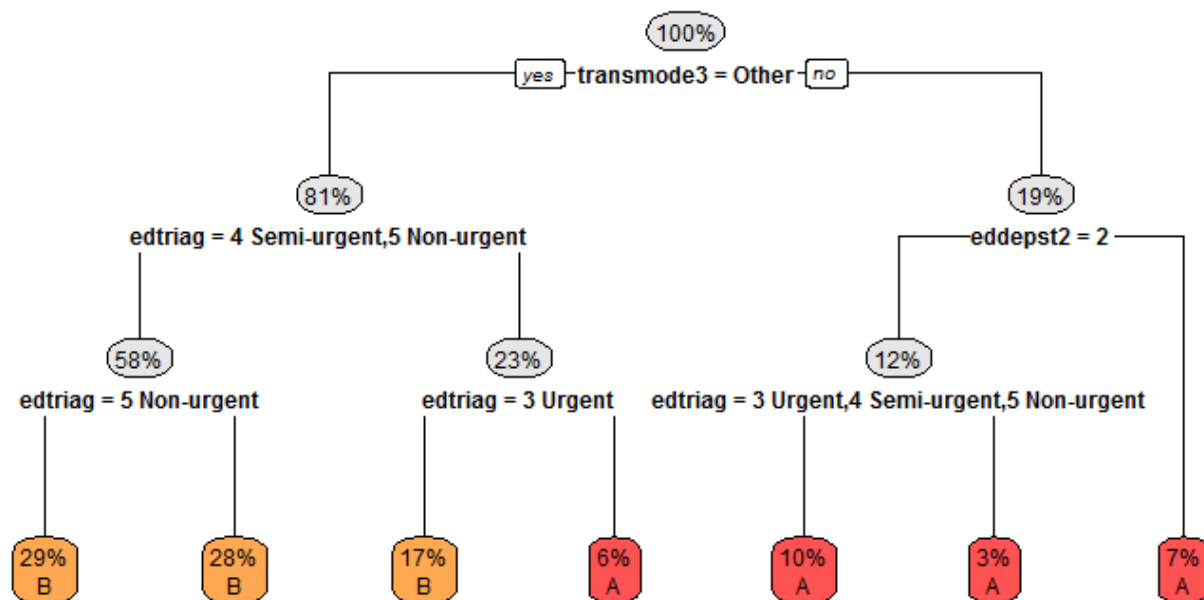



# AECC grouping logic

This Chapter shows the AECC grouping logic in text form.

The legend for the variable names and values is in the previous Chapter. For ECDGs with multiple levels, level A is the most complex, level B is the next most complex etc. Where there is only one level, level A does not relate to complexity.

| Emergency care level 1 category and diagnosis group (ECDG) | Complexity level | Logic  |
|--|------------------|--|
| A01 Did not wait   | A                |  |
| A02A Return Visit, planned, planned Triage=1,2             | A                |  |
| A02B Return Visit, planned, planned Triage=3,4,5           | A                |  |
| A03 Dead on arrival  | A                |  |
| A04A Referred to another hospital, planned Triage=1,2      | A                |  |
| A04B Referred to another hospital, planned Triage=3,4,5    | A                |  |
| A05 Died in ED   | A                |  |
| A06A Left at own risk, planned Triage=1,2                  | A                |  |
| A06B Left at own risk, planned Triage=3,4,5                | A                |  |
| B63 Dementia/ chronic brain syndrome                       | A                | eddepst2=1_3_6 >> edtriag=1 Resuscitation,3 Urgent   |
| B63 Dementia/ chronic brain syndrome                       | B                | eddepst2=1_3_6 >> edtriag=2 Emergency,4 Semi-urgent,5 Non-urgent   |
| B63 Dementia/ chronic brain syndrome                       | C                | eddepst2=2   |
| B64 Delirium/ confusion/ acute encephalopathy              | A                | edtriag=3 Urgent,4 Semi-urgent >> eddepst2=2 >> agegrp3=70-74,75-79,80-84                                      |
| B64 Delirium/ confusion/ acute encephalopathy              | A                | edtriag=3 Urgent,4 Semi-urgent >> eddepst2=2 >> agegrp3=15-69,5-9,85+  |
| B64 Delirium/ confusion/ acute encephalopathy              | A                | edtriag=3 Urgent,4 Semi-urgent >> eddepst2=1_3_6 >> agegrp3=0-4,85+  |
| B64 Delirium/ confusion/ acute encephalopathy              | A                | edtriag=3 Urgent,4 Semi-urgent >> eddepst2=1_3_6 >> agegrp3=15-69,70-74,75-79,80-84                            |
| B64 Delirium/ confusion/ acute encephalopathy              | A                | edtriag=1 Resuscitation,2 Emergency >> transmode3=Other  |
| B64 Delirium/ confusion/ acute encephalopathy              | A                | edtriag=1 Resuscitation,2 Emergency >> transmode3=1 >> agegrp3=15-69,80-84                                     |
| B64 Delirium/ confusion/ acute encephalopathy              | A                | edtriag=1 Resuscitation,2 Emergency >> transmode3=1 >> agegrp3=70-74,75-79,85+                                 |
| B69 TIA and precerebral occlusion                          | A                |  |
| B70 Stroke & other cerebrovascular disorders               | A                | edtriag=1 Resuscitation,2 Emergency,3 Urgent >> edtriag=3 Urgent >> transmode3=1                               |
| B70 Stroke & other cerebrovascular disorders               | A                | edtriag=1 Resuscitation,2 Emergency,3 Urgent >> edtriag=1 Resuscitation,2 Emergency >> agegrp3=70-74,80-84,85+ |
| B70 Stroke & other cerebrovascular disorders               | A                | edtriag=1 Resuscitation,2 Emergency,3 Urgent >> edtriag=1 Resuscitation,2 Emergency >> agegrp3=15-69,75-79     |
| B70 Stroke & other cerebrovascular disorders               | B                | edtriag=4 Semi-urgent  |
| B70 Stroke & other cerebrovascular disorders               | B                | edtriag=1 Resuscitation,2 Emergency,3 Urgent >> edtriag=3 Urgent >> transmode3=Other                           |
| B72 CNS infection/ inflammation                            | A                |  |
| B81 Disorders of the nervous system, other                 | A                | transmode3=1 >> edtriag=1 Resuscitation,2 Emergency >> agegrp3=70-74,85+                                       |
| B81 Disorders of the nervous system, other                 | B                | transmode3=1 >> edtriag=3 Urgent,4 Semi-urgent,5 Non-urgent >> eddepst2=1_3_6                                  |

| Emergency care level 1 category and diagnosis group (ECDG) | Complexity level | Logic   |
|--|------------------|---|
| B81 Disorders of the nervous system, other                 | B                | transmode3=1 >> edtriag=1 Resuscitation,2 Emergency >> agegrp3=0-4,10-14,15-69,5-9,75-79,80-84                      |
| B81 Disorders of the nervous system, other                 | C                | transmode3=Other >> eddepst2=2 >> edtriag=4 Semi-urgent,5 Non-urgent  |
| B81 Disorders of the nervous system, other                 | C                | transmode3=Other >> eddepst2=2 >> edtriag=1 Resuscitation,2 Emergency,3 Urgent                                      |
| B81 Disorders of the nervous system, other                 | C                | transmode3=Other >> eddepst2=1_3_6  |
| B81 Disorders of the nervous system, other                 | C                | transmode3=1 >> edtriag=3 Urgent,4 Semi-urgent,5 Non-urgent >> eddepst2=2   |
| C633 Eye disorder, other                                   | A                | eddepst2=2 >> transmode3=Other >> agegrp3=80-84   |
| C633 Eye disorder, other                                   | A                | eddepst2=2 >> transmode3=1  |
| C633 Eye disorder, other                                   | A                | eddepst2=1_3_6 >> agegrp3=0-4,10-14,15-69,5-9 >> edtriag=3 Urgent >> agegrp3=15-69                                  |
| C633 Eye disorder, other                                   | A                | eddepst2=1_3_6 >> agegrp3=70-74,75-79,85+   |
| C633 Eye disorder, other                                   | B                | eddepst2=2 >> transmode3=Other >> agegrp3=0-4,10-14,15-69,5-9,70-74,75-79,85+ >> edtriag=4 Semi-urgent,5 Non-urgent |
| C633 Eye disorder, other                                   | B                | eddepst2=2 >> transmode3=Other >> agegrp3=0-4,10-14,15-69,5-9,70-74,75-79,85+ >> edtriag=2 Emergency,3 Urgent       |
| C633 Eye disorder, other                                   | B                | eddepst2=1_3_6 >> agegrp3=0-4,10-14,15-69,5-9 >> edtriag=2 Emergency,4 Semi-urgent,5 Non-urgent                     |
| C633 Eye disorder, other                                   | B                | eddepst2=1_3_6 >> agegrp3=0-4,10-14,15-69,5-9 >> edtriag=3 Urgent >> agegrp3=0-4,10-14,5-9                          |
| D66 Ear, nose, mouth and throat disorders, other           | A                | eddepst2=1_3_6 >> agegrp3=0-4,10-14,15-69,5-9,70-74,75-79,85+ >> transmode3=1                                       |
| D66 Ear, nose, mouth and throat disorders, other           | A                | eddepst2=1_3_6 >> agegrp3=80-84   |
| D66 Ear, nose, mouth and throat disorders, other           | B                | eddepst2=2 >> transmode3=1  |
| D66 Ear, nose, mouth and throat disorders, other           | B                | eddepst2=1_3_6 >> agegrp3=0-4,10-14,15-69,5-9,70-74,75-79,85+ >> transmode3=Other                                   |
| D66 Ear, nose, mouth and throat disorders, other           | C                | eddepst2=2 >> transmode3=Other >> edtriag=4 Semi-urgent,5 Non-urgent  |
| D66 Ear, nose, mouth and throat disorders, other           | C                | eddepst2=2 >> transmode3=Other >> edtriag=2 Emergency,3 Urgent  |
| D671 Teeth and supporting structures disorders, other      | A                | transmode3=Other >> edtriag=2 Emergency,3 Urgent >> eddepst2=1_3_6  |
| D671 Teeth and supporting structures disorders, other      | A                | transmode3=1 >> eddepst2=2  |
| D671 Teeth and supporting structures disorders, other      | A                | transmode3=1 >> eddepst2=1_3_6  |
| D671 Teeth and supporting structures disorders, other      | B                | transmode3=Other >> edtriag=4 Semi-urgent,5 Non-urgent  |
| D671 Teeth and supporting structures disorders, other      | B                | transmode3=Other >> edtriag=2 Emergency,3 Urgent >> eddepst2=2  |
| E61 Major respiratory diagnosis                            | A                | agegrp3=15-69,75-79,80-84,85+ >> edtriag=1 Resuscitation,2 Emergency >> transmode3=Other                            |
| E61 Major respiratory diagnosis                            | A                | agegrp3=15-69,75-79,80-84,85+ >> edtriag=1 Resuscitation,2 Emergency >> transmode3=1                                |
| E61 Major respiratory diagnosis                            | B                | agegrp3=0-4,70-74   |
| E61 Major respiratory diagnosis                            | B                | agegrp3=15-69,75-79,80-84,85+ >> edtriag=3 Urgent,4 Semi-urgent   |
| E623 Upper respiratory tract infection (URTI), other       | A                | transmode3=Other >> eddepst2=2 >> edtriag=2 Emergency,3 Urgent >> agegrp3=15-69,85+                                 |
| E623 Upper respiratory tract infection (URTI), other       | A                | transmode3=Other >> eddepst2=1_3_6  |
| E623 Upper respiratory tract infection (URTI), other       | A                | transmode3=1 >> agegrp3=0-4,5-9   |
| E623 Upper respiratory tract infection (URTI), other       | A                | transmode3=1 >> agegrp3=10-14,15-69,70-74,75-79,80-84,85+ >> agegrp3=10-14,15-69,75-79                              |
| E623 Upper respiratory tract infection (URTI), other       | A                | transmode3=1 >> agegrp3=10-14,15-69,70-74,75-79,80-84,85+ >> agegrp3=70-74,80-84,85+                                |
| E623 Upper respiratory tract infection                     | B                | transmode3=Other >> eddepst2=2 >> edtriag=4 Semi-   |

| Emergency care level 1 category and diagnosis group (ECDG) | Complexity level | Logic   |
|--|------------------|---|
| (URTI), other  |                  | urgent,5 Non-urgent   |
| E623 Upper respiratory tract infection (URTI), other       | B                | transmode3=Other >> eddepst2=2 >> edtriag=2 Emergency,3 Urgent >> agegrp3=0-4,10-14,5-9                     |
| E65 Chronic obstructive airways disease                    | A                | eddepst2=2 >> transmode3=Other  |
| E65 Chronic obstructive airways disease                    | A                | eddepst2=2 >> transmode3=1  |
| E65 Chronic obstructive airways disease                    | A                | eddepst2=1_3_6 >> edtriag=2 Emergency,3 Urgent,4 Semi-urgent  |
| E65 Chronic obstructive airways disease                    | A                | eddepst2=1_3_6 >> edtriag=1 Resuscitation   |
| E69 Asthma/ wheeze/ croup/ airway infection                | A                | eddepst2=2 >> agegrp3=15-69,70-74,75-79,80-84,85+   |
| E69 Asthma/ wheeze/ croup/ airway infection                | A                | eddepst2=1_3_6 >> agegrp3=0-4,10-14,5-9 >> edtriag=3 Urgent,4 Semi-urgent                                   |
| E69 Asthma/ wheeze/ croup/ airway infection                | A                | eddepst2=1_3_6 >> agegrp3=0-4,10-14,5-9 >> edtriag=1 Resuscitation,2 Emergency                              |
| E69 Asthma/ wheeze/ croup/ airway infection                | A                | eddepst2=1_3_6 >> agegrp3=15-69,70-74,75-79,80-84,85+ >> transmode3=Other                                   |
| E69 Asthma/ wheeze/ croup/ airway infection                | A                | eddepst2=1_3_6 >> agegrp3=15-69,70-74,75-79,80-84,85+ >> transmode3=1                                       |
| E69 Asthma/ wheeze/ croup/ airway infection                | B                | eddepst2=2 >> agegrp3=0-4,10-14,5-9 >> edtriag=3 Urgent,4 Semi-urgent                                       |
| E69 Asthma/ wheeze/ croup/ airway infection                | B                | eddepst2=2 >> agegrp3=0-4,10-14,5-9 >> edtriag=1 Resuscitation,2 Emergency                                  |
| E753 Respiratory disorder, other                           | A                | eddepst2=2 >> transmode3=1  |
| E753 Respiratory disorder, other                           | A                | eddepst2=1_3_6 >> agegrp3=10-14,15-69,70-74,75-79,80-84,85+ >> edtriag=1 Resuscitation,2 Emergency,3 Urgent |
| E753 Respiratory disorder, other                           | B                | eddepst2=2 >> transmode3=Other >> agegrp3=0-4,10-14,5-9   |
| E753 Respiratory disorder, other                           | B                | eddepst2=2 >> transmode3=Other >> agegrp3=15-69,70-74,75-79,80-84,85+                                       |
| E753 Respiratory disorder, other                           | B                | eddepst2=1_3_6 >> agegrp3=0-4,5-9   |
| E753 Respiratory disorder, other                           | B                | eddepst2=1_3_6 >> agegrp3=10-14,15-69,70-74,75-79,80-84,85+ >> edtriag=4 Semi-urgent,5 Non-urgent           |
| F60 Acute coronary syndrome                                | A                | eddepst2=1_3_6 >> transmode3=Other  |
| F60 Acute coronary syndrome                                | A                | eddepst2=1_3_6 >> transmode3=1  |
| F60 Acute coronary syndrome                                | A                | eddepst2=2  |
| F62 Heart failure and shock                                | A                | transmode3=1 >> agegrp3=15-69,75-79,80-84   |
| F62 Heart failure and shock                                | B                | transmode3=Other >> edtriag=3 Urgent,4 Semi-urgent  |
| F62 Heart failure and shock                                | B                | transmode3=Other >> edtriag=1 Resuscitation,2 Emergency   |
| F62 Heart failure and shock                                | B                | transmode3=1 >> agegrp3=70-74,85+   |
| F74 Chest pain   | A                | transmode3=1 >> edtriag=1 Resuscitation,2 Emergency   |
| F74 Chest pain   | B                | transmode3=Other >> edtriag=4 Semi-urgent,5 Non-urgent  |
| F74 Chest pain   | B                | transmode3=Other >> edtriag=1 Resuscitation,2 Emergency,3 Urgent  |
| F74 Chest pain   | B                | transmode3=1 >> edtriag=3 Urgent,4 Semi-urgent,5 Non-urgent   |
| F75 Circulatory disorder, other                            | A                | edtriag=1 Resuscitation,2 Emergency >> transmode3=1 >> eddepst2=2 >> agegrp3=75-79                          |
| F75 Circulatory disorder, other                            | A                | edtriag=1 Resuscitation,2 Emergency >> transmode3=1 >> eddepst2=1_3_6                                       |
| F75 Circulatory disorder, other                            | B                | edtriag=3 Urgent,4 Semi-urgent,5 Non-urgent >> transmode3=1   |
| F75 Circulatory disorder, other                            | B                | edtriag=1 Resuscitation,2 Emergency >> transmode3=Other   |
| F75 Circulatory disorder, other                            | B                | edtriag=1 Resuscitation,2 Emergency >> transmode3=1 >> eddepst2=2 >> agegrp3=10-14,15-69,70-74,80-84,85+    |
| F75 Circulatory disorder, other                            | C                | edtriag=3 Urgent,4 Semi-urgent,5 Non-urgent >> transmode3=Other   |

| Emergency care level 1 category and diagnosis group (ECDG) | Complexity level | Logic   |
|--|------------------|---|
| F76 Arrhythmia and cardiac arrest                          | A                | eddepst2=2 >> edtriag=1 Resuscitation,2 Emergency >> agegrp3=80-84,85+  |
| F76 Arrhythmia and cardiac arrest                          | A                | eddepst2=1_3_6 >> agegrp3=0-4,15-69,75-79 >> transmode3=1   |
| F76 Arrhythmia and cardiac arrest                          | A                | eddepst2=1_3_6 >> agegrp3=5-9,70-74,80-84,85+   |
| F76 Arrhythmia and cardiac arrest                          | B                | eddepst2=2 >> edtriag=3 Urgent,4 Semi-urgent >> edtriag=4 Semi-urgent   |
| F76 Arrhythmia and cardiac arrest                          | B                | eddepst2=2 >> edtriag=3 Urgent,4 Semi-urgent >> edtriag=3 Urgent  |
| F76 Arrhythmia and cardiac arrest                          | B                | eddepst2=2 >> edtriag=1 Resuscitation,2 Emergency >> agegrp3=0-4,10-14,15-69,5-9,70-74,75-79                          |
| F76 Arrhythmia and cardiac arrest                          | B                | eddepst2=1_3_6 >> agegrp3=0-4,15-69,75-79 >> transmode3=Other   |
| G61 Gastrointestinal haemorrhage                           | A                | eddepst2=1_3_6 >> transmode3=Other >> edtriag=2 Emergency   |
| G61 Gastrointestinal haemorrhage                           | A                | eddepst2=1_3_6 >> transmode3=1 >> agegrp3=0-4,70-74,85+   |
| G61 Gastrointestinal haemorrhage                           | A                | eddepst2=1_3_6 >> transmode3=1 >> agegrp3=15-69,75-79,80-84 >> edtriag=2 Emergency,4 Semi-urgent                      |
| G61 Gastrointestinal haemorrhage                           | A                | eddepst2=1_3_6 >> transmode3=1 >> agegrp3=15-69,75-79,80-84 >> edtriag=1 Resuscitation,3 Urgent                       |
| G61 Gastrointestinal haemorrhage                           | B                | eddepst2=2  |
| G61 Gastrointestinal haemorrhage                           | B                | eddepst2=1_3_6 >> transmode3=Other >> edtriag=3 Urgent,4 Semi-urgent  |
| G65 Gastrointestinal obstruction                           | A                | edtriag=4 Semi-urgent   |
| G65 Gastrointestinal obstruction                           | A                | edtriag=2 Emergency,3 Urgent >> transmode3=Other >> agegrp3=75-79,80-84,85+   |
| G65 Gastrointestinal obstruction                           | A                | edtriag=2 Emergency,3 Urgent >> transmode3=Other >> agegrp3=15-69,70-74   |
| G65 Gastrointestinal obstruction                           | A                | edtriag=2 Emergency,3 Urgent >> transmode3=1  |
| G661 Gastrointestinal peritonitis/perforation              | A                | edtriag=3 Urgent,4 Semi-urgent,5 Non-urgent >> transmode3=1 >> agegrp3=10-14,15-69,5-9,70-74 >> edtriag=3 Urgent      |
| G661 Gastrointestinal peritonitis/perforation              | A                | edtriag=3 Urgent,4 Semi-urgent,5 Non-urgent >> transmode3=1 >> agegrp3=0-4,75-79,80-84,85+                            |
| G661 Gastrointestinal peritonitis/perforation              | A                | edtriag=1 Resuscitation,2 Emergency   |
| G661 Gastrointestinal peritonitis/perforation              | B                | edtriag=3 Urgent,4 Semi-urgent,5 Non-urgent >> transmode3=Other   |
| G661 Gastrointestinal peritonitis/perforation              | B                | edtriag=3 Urgent,4 Semi-urgent,5 Non-urgent >> transmode3=1 >> agegrp3=10-14,15-69,5-9,70-74 >> edtriag=4 Semi-urgent |
| G662 Abdominal pain  | A                | eddepst2=2 >> transmode3=1  |
| G662 Abdominal pain  | A                | eddepst2=1_3_6 >> transmode3=Other  |
| G662 Abdominal pain  | A                | eddepst2=1_3_6 >> transmode3=1  |
| G662 Abdominal pain  | B                | eddepst2=2 >> transmode3=Other >> agegrp3=0-4,10-14,5-9   |
| G662 Abdominal pain  | B                | eddepst2=2 >> transmode3=Other >> agegrp3=15-69,70-74,75-79,80-84,85+   |
| G67 Oesophagitis and gastroenteritis                       | A                | eddepst2=2 >> agegrp3=15-69,70-74,75-79,80-84,85+ >> agegrp3=15-69,75-79,80-84 >> edtriag=2 Emergency,3 Urgent        |
| G67 Oesophagitis and gastroenteritis                       | A                | eddepst2=2 >> agegrp3=15-69,70-74,75-79,80-84,85+ >> agegrp3=70-74,85+  |
| G67 Oesophagitis and gastroenteritis                       | A                | eddepst2=1_3_6 >> edtriag=3 Urgent,4 Semi-urgent >> agegrp3=0-4,10-14,15-69   |
| G67 Oesophagitis and gastroenteritis                       | A                | eddepst2=1_3_6 >> edtriag=3 Urgent,4 Semi-urgent >> agegrp3=5-9,70-74,75-79,80-84,85+                                 |
| G67 Oesophagitis and gastroenteritis                       | A                | eddepst2=1_3_6 >> edtriag=2 Emergency >> transmode3=Other   |
| G67 Oesophagitis and gastroenteritis                       | A                | eddepst2=1_3_6 >> edtriag=2 Emergency >> transmode3=1   |
| G67 Oesophagitis and gastroenteritis                       | B                | eddepst2=2 >> agegrp3=0-4,10-14,5-9   |

| Emergency care level 1 category and diagnosis group (ECDG)             | Complexity level | Logic  |
|--|------------------|--|
| G67 Oesophagitis and gastroenteritis                                   | B                | eddepst2=2 >> agegrp3=15-69,70-74,75-79,80-84,85+ >> agegrp3=15-69,75-79,80-84 >> edtriag=4 Semi-urgent,5 Non-urgent |
| G702 Digestive system disorders, other                                 | A                | transmode3=1 >> edtriag=1 Resuscitation,2 Emergency,3 Urgent >> agegrp3=0-4,15-69,75-79                              |
| G702 Digestive system disorders, other                                 | A                | transmode3=1 >> edtriag=1 Resuscitation,2 Emergency,3 Urgent >> agegrp3=70-74,80-84,85+                              |
| G702 Digestive system disorders, other                                 | B                | transmode3=Other >> eddepst2=2 >> edtriag=2 Emergency  |
| G702 Digestive system disorders, other                                 | B                | transmode3=Other >> eddepst2=1_3_6   |
| G702 Digestive system disorders, other                                 | B                | transmode3=1 >> edtriag=4 Semi-urgent,5 Non-urgent   |
| G702 Digestive system disorders, other                                 | C                | transmode3=Other >> eddepst2=2 >> edtriag=3 Urgent,4 Semi-urgent,5 Non-urgent  |
| H63 Disorders of liver   | A                | transmode3=1 >> edtriag=1 Resuscitation,2 Emergency  |
| H63 Disorders of liver   | B                | transmode3=Other >> agegrp3=15-69,80-84,85+  |
| H63 Disorders of liver   | B                | transmode3=1 >> edtriag=3 Urgent,4 Semi-urgent   |
| H63 Disorders of liver   | C                | transmode3=Other >> agegrp3=0-4,75-79  |
| H64 Disorder of the biliary tract                                      | A                | transmode3=Other >> eddepst2=1_3_6 >> agegrp3=75-79,80-84,85+  |
| H64 Disorder of the biliary tract                                      | A                | transmode3=1 >> edtriag=3 Urgent,4 Semi-urgent >> agegrp3=80-84,85+  |
| H64 Disorder of the biliary tract                                      | A                | transmode3=1 >> edtriag=1 Resuscitation,2 Emergency  |
| H64 Disorder of the biliary tract                                      | B                | transmode3=Other >> eddepst2=2 >> edtriag=4 Semi-urgent  |
| H64 Disorder of the biliary tract                                      | B                | transmode3=Other >> eddepst2=2 >> edtriag=2 Emergency,3 Urgent   |
| H64 Disorder of the biliary tract                                      | B                | transmode3=Other >> eddepst2=1_3_6 >> agegrp3=10-14,15-69,70-74  |
| H64 Disorder of the biliary tract                                      | B                | transmode3=1 >> edtriag=3 Urgent,4 Semi-urgent >> agegrp3=15-69,75-79  |
| I01 Major injury   | A                | transmode3=Other >> edtriag=1 Resuscitation,2 Emergency >> agegrp3=15-69,70-74,75-79                                 |
| I01 Major injury   | A                | transmode3=1 >> eddepst2=2 >> agegrp3=15-69,70-74,75-79,80-84,85+  |
| I01 Major injury   | A                | transmode3=1 >> eddepst2=1_3_6 >> edtriag=3 Urgent,4 Semi-urgent,5 Non-urgent  |
| I01 Major injury   | A                | transmode3=1 >> eddepst2=1_3_6 >> edtriag=1 Resuscitation,2 Emergency  |
| I01 Major injury   | B                | transmode3=Other >> edtriag=3 Urgent,4 Semi-urgent,5 Non-urgent  |
| I01 Major injury   | B                | transmode3=Other >> edtriag=1 Resuscitation,2 Emergency >> agegrp3=0-4,10-14,5-9,85+                                 |
| I01 Major injury   | B                | transmode3=1 >> eddepst2=2 >> agegrp3=0-4,10-14,5-9  |
| I02 Fractures of neck of femur   | A                | edtriag=3 Urgent,4 Semi-urgent >> transmode3=1 >> agegrp3=15-69,70-74,80-84,85+ >> agegrp3=70-74,80-84               |
| I02 Fractures of neck of femur   | A                | edtriag=1 Resuscitation,2 Emergency  |
| I02 Fractures of neck of femur   | B                | edtriag=3 Urgent,4 Semi-urgent >> transmode3=1 >> agegrp3=15-69,70-74,80-84,85+ >> agegrp3=15-69,85+                 |
| I02 Fractures of neck of femur   | C                | edtriag=3 Urgent,4 Semi-urgent >> transmode3=Other   |
| I02 Fractures of neck of femur   | C                | edtriag=3 Urgent,4 Semi-urgent >> transmode3=1 >> agegrp3=0-4,10-14,75-79  |
| I03 Fracture of shoulder and lower leg, dislocation, sprain and strain | A                | transmode3=Other >> edtriag=2 Emergency,3 Urgent >> eddepst2=1_3_6   |
| I03 Fracture of shoulder and lower leg, dislocation, sprain and strain | A                | transmode3=1 >> eddepst2=1_3_6 >> edtriag=3 Urgent,4 Semi-urgent   |
| I03 Fracture of shoulder and lower leg, dislocation, sprain and strain | A                | transmode3=1 >> eddepst2=1_3_6 >> edtriag=1 Resuscitation,2 Emergency,5 Non-urgent                                   |
| I03 Fracture of shoulder and lower leg, dislocation, sprain and strain | B                | transmode3=Other >> edtriag=1 Resuscitation,4 Semi-urgent,5 Non-urgent >> agegrp3=70-74,75-79,80-84                  |
| I03 Fracture of shoulder and lower leg, dislocation, sprain and strain | B                | transmode3=Other >> edtriag=2 Emergency,3 Urgent >> eddepst2=2 >> edtriag=2 Emergency                                |



| Emergency care level 1 category and diagnosis group (ECDG)                | Complexity level | Logic  |
|---|------------------|--|
| I03 Fracture of shoulder and lower leg, dislocation, sprain and strain    | B                | transmode3=1 >> eddepst2=2   |
| I03 Fracture of shoulder and lower leg, dislocation, sprain and strain    | C                | transmode3=Other >> edtriag=1 Resuscitation,4 Semi-urgent,5 Non-urgent >> agegrp3=0-4,10-14,15-69,5-9,85+                    |
| I03 Fracture of shoulder and lower leg, dislocation, sprain and strain    | C                | transmode3=Other >> edtriag=2 Emergency,3 Urgent >> eddepst2=2 >> edtriag=3 Urgent   |
| I04 Injuries, fractures (forearm, wrist, ankle, foot), and other injuries | A                | transmode3=Other >> edtriag=4 Semi-urgent,5 Non-urgent >> agegrp3=70-74,80-84,85+  |
| I04 Injuries, fractures (forearm, wrist, ankle, foot), and other injuries | A                | transmode3=Other >> edtriag=2 Emergency,3 Urgent >> eddepst2=1_3_6   |
| I04 Injuries, fractures (forearm, wrist, ankle, foot), and other injuries | A                | transmode3=1 >> agegrp3=0-4,10-14,15-69,5-9,80-84,85+  |
| I04 Injuries, fractures (forearm, wrist, ankle, foot), and other injuries | A                | transmode3=1 >> agegrp3=70-74,75-79  |
| I04 Injuries, fractures (forearm, wrist, ankle, foot), and other injuries | B                | transmode3=Other >> edtriag=4 Semi-urgent,5 Non-urgent >> agegrp3=0-4,10-14,15-69,5-9,75-79                                  |
| I04 Injuries, fractures (forearm, wrist, ankle, foot), and other injuries | B                | transmode3=Other >> edtriag=2 Emergency,3 Urgent >> eddepst2=2   |
| I05 Injury, other   | A                | transmode3=1 >> edtriag=3 Urgent,4 Semi-urgent,5 Non-urgent >> eddepst2=1_3_6 >> edtriag=3 Urgent                            |
| I05 Injury, other   | A                | transmode3=1 >> edtriag=1 Resuscitation,2 Emergency  |
| I05 Injury, other   | B                | transmode3=Other >> edtriag=3 Urgent,4 Semi-urgent,5 Non-urgent >> eddepst2=1_3_6  |
| I05 Injury, other   | B                | transmode3=Other >> edtriag=1 Resuscitation,2 Emergency  |
| I05 Injury, other   | B                | transmode3=1 >> edtriag=3 Urgent,4 Semi-urgent,5 Non-urgent >> eddepst2=2  |
| I05 Injury, other   | B                | transmode3=1 >> edtriag=3 Urgent,4 Semi-urgent,5 Non-urgent >> eddepst2=1_3_6 >> edtriag=4 Semi-urgent                       |
| I05 Injury, other   | C                | transmode3=Other >> edtriag=3 Urgent,4 Semi-urgent,5 Non-urgent >> eddepst2=2  |
| I06 Minor injury  | A                | transmode3=Other >> edtriag=3 Urgent,4 Semi-urgent,5 Non-urgent >> edtriag=3 Urgent >> agegrp3=75-79,80-84                   |
| I06 Minor injury  | B                | transmode3=Other >> edtriag=1 Resuscitation,2 Emergency  |
| I06 Minor injury  | B                | transmode3=1 >> edtriag=3 Urgent,4 Semi-urgent,5 Non-urgent  |
| I06 Minor injury  | B                | transmode3=1 >> edtriag=1 Resuscitation,2 Emergency  |
| I06 Minor injury  | C                | transmode3=Other >> edtriag=3 Urgent,4 Semi-urgent,5 Non-urgent >> edtriag=4 Semi-urgent,5 Non-urgent                        |
| I06 Minor injury  | C                | transmode3=Other >> edtriag=3 Urgent,4 Semi-urgent,5 Non-urgent >> edtriag=3 Urgent >> agegrp3=0-4,10-14,15-69,5-9,70-74,85+ |
| I71 Musculotendinous disorders, other                                     | A                | transmode3=Other >> eddepst2=1_3_6   |
| I71 Musculotendinous disorders, other                                     | A                | transmode3=1   |
| I71 Musculotendinous disorders, other                                     | B                | transmode3=Other >> eddepst2=2 >> edtriag=4 Semi-urgent,5 Non-urgent   |
| I71 Musculotendinous disorders, other                                     | B                | transmode3=Other >> eddepst2=2 >> edtriag=2 Emergency,3 Urgent   |
| I85 Complications of surgical and medical care                            | A                | eddepst2=1_3_6 >> transmode3=Other >> edtriag=3 Urgent   |
| I85 Complications of surgical and medical care                            | A                | eddepst2=1_3_6 >> transmode3=1 >> agegrp3=5-9,70-74,75-79,85+  |
| I85 Complications of surgical and medical care                            | A                | eddepst2=1_3_6 >> transmode3=1 >> agegrp3=15-69,80-84  |
| I85 Complications of surgical and medical care                            | B                | eddepst2=2 >> agegrp3=15-69,70-74,75-79,80-84,85+ >> edtriag=2 Emergency,3 Urgent,4 Semi-urgent                              |
| I85 Complications of surgical and medical care                            | B                | eddepst2=1_3_6 >> transmode3=Other >> edtriag=2 Emergency,4 Semi-urgent  |
| I85 Complications of surgical and medical care                            | C                | eddepst2=2 >> agegrp3=0-4,10-14,5-9  |

| Emergency care level 1 category and diagnosis group (ECDG)   | Complexity level | Logic  |
|--|------------------|--|
| I85 Complications of surgical and medical care               | C                | eddepst2=2 >> agegrp3=15-69,70-74,75-79,80-84,85+ >> edtriag=5 Non-urgent  |
| J64 Cellulitis/ skin infection                               | A                | transmode3=1 >> eddepst2=1_3_6   |
| J64 Cellulitis/ skin infection                               | B                | transmode3=Other >> eddepst2=2 >> agegrp3=0-4,10-14,15-69,5-9,70-74,80-84  |
| J64 Cellulitis/ skin infection                               | B                | transmode3=Other >> eddepst2=2 >> agegrp3=75-79,85+  |
| J64 Cellulitis/ skin infection                               | B                | transmode3=Other >> eddepst2=1_3_6   |
| J64 Cellulitis/ skin infection                               | B                | transmode3=1 >> eddepst2=2   |
| J67 Skin disorders, other                                    | A                | transmode3=Other >> eddepst2=1_3_6   |
| J67 Skin disorders, other                                    | A                | transmode3=1 >> eddepst2=2   |
| J67 Skin disorders, other                                    | A                | transmode3=1 >> eddepst2=1_3_6   |
| J67 Skin disorders, other                                    | B                | transmode3=Other >> eddepst2=2 >> edtriag=4 Semi-urgent,5 Non-urgent   |
| J67 Skin disorders, other                                    | B                | transmode3=Other >> eddepst2=2 >> edtriag=2 Emergency,3 Urgent   |
| K60 Diabetes   | A                | transmode3=Other >> edtriag=1 Resuscitation,2 Emergency  |
| K60 Diabetes   | A                | transmode3=1 >> edtriag=1 Resuscitation,3 Urgent,4 Semi-urgent >> edtriag=3 Urgent                                   |
| K60 Diabetes   | A                | transmode3=1 >> edtriag=2 Emergency  |
| K60 Diabetes   | B                | transmode3=Other >> edtriag=3 Urgent,4 Semi-urgent,5 Non-urgent >> edtriag=4 Semi-urgent,5 Non-urgent                |
| K60 Diabetes   | B                | transmode3=Other >> edtriag=3 Urgent,4 Semi-urgent,5 Non-urgent >> edtriag=3 Urgent                                  |
| K60 Diabetes   | B                | transmode3=1 >> edtriag=1 Resuscitation,3 Urgent,4 Semi-urgent >> edtriag=1 Resuscitation,4 Semi-urgent              |
| K62 Miscellaneous metabolic disorders                        | A                | transmode3=Other >> agegrp3=10-14,70-74  |
| K62 Miscellaneous metabolic disorders                        | A                | transmode3=1 >> edtriag=3 Urgent,4 Semi-urgent,5 Non-urgent >> agegrp3=10-14,15-69,75-79,80-84,85+ >> eddepst2=1_3_6 |
| K62 Miscellaneous metabolic disorders                        | A                | transmode3=1 >> edtriag=3 Urgent,4 Semi-urgent,5 Non-urgent >> agegrp3=0-4,70-74                                     |
| K62 Miscellaneous metabolic disorders                        | A                | transmode3=1 >> edtriag=1 Resuscitation,2 Emergency  |
| K62 Miscellaneous metabolic disorders                        | B                | transmode3=Other >> agegrp3=0-4,15-69,5-9,75-79,80-84,85+  |
| K62 Miscellaneous metabolic disorders                        | B                | transmode3=1 >> edtriag=3 Urgent,4 Semi-urgent,5 Non-urgent >> agegrp3=10-14,15-69,75-79,80-84,85+ >> eddepst2=2     |
| L60 Renal failure  | A                | agegrp3=10-14,15-69,70-74 >> transmode3=1  |
| L60 Renal failure  | A                | agegrp3=75-79,80-84,85+ >> edtriag=2 Emergency,4 Semi-urgent   |
| L60 Renal failure  | A                | agegrp3=75-79,80-84,85+ >> edtriag=3 Urgent  |
| L60 Renal failure  | B                | agegrp3=10-14,15-69,70-74 >> transmode3=Other >> edtriag=3 Urgent  |
| L60 Renal failure  | B                | agegrp3=10-14,15-69,70-74 >> transmode3=Other >> edtriag=2 Emergency,4 Semi-urgent                                   |
| L672 Kidney and urinary tract disorder, other                | A                | transmode3=Other >> eddepst2=2 >> edtriag=1 Resuscitation,2 Emergency  |
| L672 Kidney and urinary tract disorder, other                | A                | transmode3=Other >> eddepst2=1_3_6   |
| L672 Kidney and urinary tract disorder, other                | A                | transmode3=1 >> edtriag=1 Resuscitation,3 Urgent,4 Semi-urgent,5 Non-urgent  |
| L672 Kidney and urinary tract disorder, other                | A                | transmode3=1 >> edtriag=2 Emergency  |
| L672 Kidney and urinary tract disorder, other                | B                | transmode3=Other >> eddepst2=2 >> edtriag=3 Urgent,4 Semi-urgent,5 Non-urgent  |
| M64 Male reproductive system disorders                       | A                |  |
| N62 Menstrual and other female reproductive system disorders | A                |  |

| Emergency care level 1 category and diagnosis group (ECDG) | Complexity level | Logic  |
|--|------------------|--|
| O61 Postpartum and post abortion                           | A                |  |
| O66 Antenatal and other obstetric presentation             | A                | edtriag=5 Non-urgent   |
| O66 Antenatal and other obstetric presentation             | A                | edtriag=1 Resuscitation,2 Emergency,3 Urgent,4 Semi-urgent >> transmode3=Other >> edtriag=4 Semi-urgent                      |
| O66 Antenatal and other obstetric presentation             | A                | edtriag=1 Resuscitation,2 Emergency,3 Urgent,4 Semi-urgent >> transmode3=Other >> edtriag=2 Emergency,3 Urgent               |
| O66 Antenatal and other obstetric presentation             | A                | edtriag=1 Resuscitation,2 Emergency,3 Urgent,4 Semi-urgent >> transmode3=1   |
| P68 Perinatal disorders                                    | A                | eddepst2=1_3_6   |
| P68 Perinatal disorders                                    | B                | eddepst2=2   |
| Q60 Reticuloendothelial and immunity disorder              | A                | edtriag=4 Semi-urgent,5 Non-urgent >> eddepst2=1_3_6   |
| Q60 Reticuloendothelial and immunity disorder              | A                | edtriag=2 Emergency,3 Urgent >> transmode3=Other >> agegrp3=10-14,15-69,70-74,75-79  |
| Q60 Reticuloendothelial and immunity disorder              | A                | edtriag=2 Emergency,3 Urgent >> transmode3=1   |
| Q60 Reticuloendothelial and immunity disorder              | B                | edtriag=4 Semi-urgent,5 Non-urgent >> eddepst2=2   |
| Q60 Reticuloendothelial and immunity disorder              | B                | edtriag=2 Emergency,3 Urgent >> transmode3=Other >> agegrp3=0-4,5-9  |
| Q61 Red blood cell disorders                               | A                | agegrp3=0-4,10-14,15-69,70-74,75-79,85+ >> transmode3=Other >> edtriag=2 Emergency,3 Urgent >> agegrp3=0-4,10-14,15-69,70-74 |
| Q61 Red blood cell disorders                               | A                | agegrp3=0-4,10-14,15-69,70-74,75-79,85+ >> transmode3=Other >> edtriag=2 Emergency,3 Urgent >> agegrp3=75-79,85+             |
| Q61 Red blood cell disorders                               | A                | agegrp3=0-4,10-14,15-69,70-74,75-79,85+ >> transmode3=1  |
| Q61 Red blood cell disorders                               | A                | agegrp3=80-84  |
| Q61 Red blood cell disorders                               | B                | agegrp3=0-4,10-14,15-69,70-74,75-79,85+ >> transmode3=Other >> edtriag=4 Semi-urgent,5 Non-urgent                            |
| Q62 Haemostasis  | A                | eddepst2=1_3_6   |
| Q62 Haemostasis  | B                | eddepst2=2 >> agegrp3=10-14,15-69,5-9  |
| Q62 Haemostasis  | C                | eddepst2=2 >> agegrp3=0-4,70-74,80-84,85+  |
| R62 Neoplastic disorders                                   | A                | edtriag=2 Emergency  |
| R62 Neoplastic disorders                                   | B                | edtriag=1 Resuscitation,3 Urgent,4 Semi-urgent,5 Non-urgent >> eddepst2=2  |
| R62 Neoplastic disorders                                   | B                | edtriag=1 Resuscitation,3 Urgent,4 Semi-urgent,5 Non-urgent >> eddepst2=1_3_6  |
| T60 Septicaemia  | A                | agegrp3=15-69,70-74,75-79,80-84,85+ >> agegrp3=70-74,80-84   |
| T60 Septicaemia  | A                | agegrp3=15-69,70-74,75-79,80-84,85+ >> agegrp3=15-69,75-79,85+ >> transmode3=Other >> edtriag=3 Urgent,4 Semi-urgent         |
| T60 Septicaemia  | A                | agegrp3=15-69,70-74,75-79,80-84,85+ >> agegrp3=15-69,75-79,85+ >> transmode3=1   |
| T60 Septicaemia  | B                | agegrp3=0-4  |
| T60 Septicaemia  | B                | agegrp3=15-69,70-74,75-79,80-84,85+ >> agegrp3=15-69,75-79,85+ >> transmode3=Other >> edtriag=2 Emergency,5 Non-urgent       |
| T62 Fever of unknown origin                                | A                | agegrp3=10-14,15-69,70-74,75-79,80-84,85+ >> edtriag=2 Emergency,3 Urgent  |
| T62 Fever of unknown origin                                | B                | agegrp3=0-4,5-9 >> eddepst2=2  |
| T62 Fever of unknown origin                                | B                | agegrp3=0-4,5-9 >> eddepst2=1_3_6  |
| T62 Fever of unknown origin                                | B                | agegrp3=10-14,15-69,70-74,75-79,80-84,85+ >> edtriag=4 Semi-urgent,5 Non-urgent  |
| T63 Viral illness  | A                | edtriag=3 Urgent,4 Semi-urgent,5 Non-urgent >> transmode3=Other >> agegrp3=0-4,10-14,5-9,85+ >> eddepst2=1_3_6               |



| Emergency care level 1 category and diagnosis group (ECDG)        | Complexity level | Logic   |
|---|------------------|---|
| T63 Viral illness   | A                | edtriag=3 Urgent,4 Semi-urgent,5 Non-urgent >> transmode3=Other >> agegrp3=15-69,70-74,75-79,80-84 >> edtriag=3 Urgent,5 Non-urgent |
| T63 Viral illness   | A                | edtriag=3 Urgent,4 Semi-urgent,5 Non-urgent >> transmode3=1   |
| T63 Viral illness   | A                | edtriag=1 Resuscitation,2 Emergency >> eddepst2=2   |
| T63 Viral illness   | A                | edtriag=1 Resuscitation,2 Emergency >> eddepst2=1_3_6   |
| T63 Viral illness   | B                | edtriag=3 Urgent,4 Semi-urgent,5 Non-urgent >> transmode3=Other >> agegrp3=0-4,10-14,5-9,85+ >> eddepst2=2                          |
| T63 Viral illness   | B                | edtriag=3 Urgent,4 Semi-urgent,5 Non-urgent >> transmode3=Other >> agegrp3=15-69,70-74,75-79,80-84 >> edtriag=4 Semi-urgent         |
| T64 Infectious and parasitic disease, other                       | A                | eddepst2=2 >> agegrp3=15-69,70-74 >> edtriag=3 Urgent,5 Non-urgent  |
| T64 Infectious and parasitic disease, other                       | A                | eddepst2=1_3_6 >> edtriag=3 Urgent,4 Semi-urgent >> agegrp3=0-4,10-14,5-9,85+   |
| T64 Infectious and parasitic disease, other                       | A                | eddepst2=1_3_6 >> edtriag=3 Urgent,4 Semi-urgent >> agegrp3=15-69   |
| T64 Infectious and parasitic disease, other                       | B                | eddepst2=2 >> agegrp3=0-4,10-14,5-9   |
| T64 Infectious and parasitic disease, other                       | B                | eddepst2=2 >> agegrp3=15-69,70-74 >> edtriag=4 Semi-urgent  |
| T64 Infectious and parasitic disease, other                       | B                | eddepst2=1_3_6 >> edtriag=2 Emergency,5 Non-urgent  |
| U62 Psychosis   | A                | transmode3=1 >> eddepst2=1_3_6 >> edtriag=1 Resuscitation,2 Emergency   |
| U62 Psychosis   | B                | transmode3=Other  |
| U62 Psychosis   | B                | transmode3=1 >> eddepst2=2  |
| U62 Psychosis   | B                | transmode3=1 >> eddepst2=1_3_6 >> edtriag=3 Urgent,4 Semi-urgent  |
| U69 Mental and behavioural disorder, other                        | A                | transmode3=1 >> eddepst2=1_3_6  |
| U69 Mental and behavioural disorder, other                        | B                | transmode3=1 >> eddepst2=2  |
| U69 Mental and behavioural disorder, other                        | C                | transmode3=Other >> edtriag=2 Emergency,3 Urgent  |
| U69 Mental and behavioural disorder, other                        | D                | transmode3=Other >> edtriag=4 Semi-urgent,5 Non-urgent  |
| V69 Alcohol and/ or drug related mental and behavioural disorders | A                | transmode3=1 >> edtriag=1 Resuscitation,2 Emergency   |
| V69 Alcohol and/ or drug related mental and behavioural disorders | B                | transmode3=Other >> edtriag=2 Emergency,3 Urgent  |
| V69 Alcohol and/ or drug related mental and behavioural disorders | B                | transmode3=1 >> edtriag=3 Urgent,4 Semi-urgent,5 Non-urgent >> eddepst2=2   |
| V69 Alcohol and/ or drug related mental and behavioural disorders | B                | transmode3=1 >> edtriag=3 Urgent,4 Semi-urgent,5 Non-urgent >> eddepst2=1_3_6   |
| V69 Alcohol and/ or drug related mental and behavioural disorders | C                | transmode3=Other >> edtriag=4 Semi-urgent,5 Non-urgent  |
| X61 Allergic reactions  | A                | edtriag=3 Urgent,4 Semi-urgent,5 Non-urgent >> transmode3=Other >> eddepst2=1_3_6   |
| X61 Allergic reactions  | A                | edtriag=3 Urgent,4 Semi-urgent,5 Non-urgent >> transmode3=1 >> agegrp3=15-69,85+  |
| X61 Allergic reactions  | A                | edtriag=1 Resuscitation,2 Emergency >> eddepst2=2   |
| X61 Allergic reactions  | A                | edtriag=1 Resuscitation,2 Emergency >> eddepst2=1_3_6 >> transmode3=Other   |
| X61 Allergic reactions  | A                | edtriag=1 Resuscitation,2 Emergency >> eddepst2=1_3_6 >> transmode3=1   |
| X61 Allergic reactions  | B                | edtriag=3 Urgent,4 Semi-urgent,5 Non-urgent >> transmode3=Other >> eddepst2=2   |
| X61 Allergic reactions  | B                | edtriag=3 Urgent,4 Semi-urgent,5 Non-urgent >> transmode3=1 >> agegrp3=0-4,10-14,5-9  |
| X62 Poisoning   | A                | edtriag=1 Resuscitation,2 Emergency >> edtriag=1 Resuscitation  |

| Emergency care level 1 category and diagnosis group (ECDG) | Complexity level | Logic  |
|--|------------------|--|
| X62 Poisoning  | B                | edtriag=3 Urgent,4 Semi-urgent,5 Non-urgent >> transmode3=1 >> eddepst2=2  |
| X62 Poisoning  | B                | edtriag=3 Urgent,4 Semi-urgent,5 Non-urgent >> transmode3=1 >> eddepst2=1_3_6  |
| X62 Poisoning  | B                | edtriag=1 Resuscitation,2 Emergency >> edtriag=2 Emergency >> transmode3=Other   |
| X62 Poisoning  | B                | edtriag=1 Resuscitation,2 Emergency >> edtriag=2 Emergency >> transmode3=1   |
| X62 Poisoning  | C                | edtriag=3 Urgent,4 Semi-urgent,5 Non-urgent >> transmode3=Other  |
| X64 Abuse and neglect                                      | A                | transmode3=1 >> edtriag=3 Urgent,4 Semi-urgent   |
| X64 Abuse and neglect                                      | A                | transmode3=1 >> edtriag=1 Resuscitation,2 Emergency  |
| X64 Abuse and neglect                                      | B                | transmode3=Other >> eddepst2=2   |
| X64 Abuse and neglect                                      | B                | transmode3=Other >> eddepst2=1_3_6   |
| Y62 Burns  | A                | transmode3=1 >> eddepst2=1_3_6   |
| Y62 Burns  | B                | transmode3=Other >> edtriag=3 Urgent,4 Semi-urgent,5 Non-urgent >> agegrp3=10-14,70-74,75-79                                       |
| Y62 Burns  | B                | transmode3=Other >> edtriag=1 Resuscitation,2 Emergency  |
| Y62 Burns  | C                | transmode3=1 >> eddepst2=2   |
| Y62 Burns  | D                | transmode3=Other >> edtriag=3 Urgent,4 Semi-urgent,5 Non-urgent >> agegrp3=0-4,15-69,5-9,85+ >> edtriag=4 Semi-urgent,5 Non-urgent |
| Y62 Burns  | D                | transmode3=Other >> edtriag=3 Urgent,4 Semi-urgent,5 Non-urgent >> agegrp3=0-4,15-69,5-9,85+ >> edtriag=3 Urgent                   |
| Z611 Falls risk  | A                |  |
| Z612 Pain syndrome   | A                |  |
| Z613 Signs and symptoms, other                             | A                |  |
| Z63 Forensic examination                                   | A                |  |
| Z64 Other factors influencing health status                | A                | transmode3=Other >> edtriag=1 Resuscitation,2 Emergency,3 Urgent >> edtriag=1 Resuscitation,2 Emergency                            |
| Z64 Other factors influencing health status                | A                | transmode3=1 >> eddepst2=2 >> edtriag=3 Urgent,4 Semi-urgent,5 Non-urgent  |
| Z64 Other factors influencing health status                | A                | transmode3=1 >> eddepst2=2 >> edtriag=1 Resuscitation,2 Emergency  |
| Z64 Other factors influencing health status                | A                | transmode3=1 >> eddepst2=1_3_6   |
| Z64 Other factors influencing health status                | B                | transmode3=Other >> edtriag=4 Semi-urgent,5 Non-urgent >> edtriag=5 Non-urgent   |
| Z64 Other factors influencing health status                | B                | transmode3=Other >> edtriag=4 Semi-urgent,5 Non-urgent >> edtriag=4 Semi-urgent  |
| Z64 Other factors influencing health status                | B                | transmode3=Other >> edtriag=1 Resuscitation,2 Emergency,3 Urgent >> edtriag=3 Urgent   |

# AECC end class costs and cost dispersion

This Chapter shows the dispersion of costs within the draft AECC end classes. The data is from the *Emergency care costing study*.

A table is shown first, with the number of stays and measures of the dispersion of the costs for the draft AECC end classes. Following this, a series of box plots is shown, representing the cost dispersion for each draft end class of the classification, organised by higher level diagnosis categories.

Note that in the table, it is the mean costs that are shown. In the box plots, it is the median.

In the box plots, the lower end of the box represents the 25th percentile of cost, the upper the 75th percentile, and the vertical line within the box the median (50th percentile). The horizontal lines on either end represent the overall dispersion of costs. The circles in the background give an indication of volumes (with more circles resulting in darker background shading representing higher volumes).

| AECC end classes   | Statistics from the <i>Emergency care costing study</i> |             |                           |                                  |
|--|---|-------------|---------------------------|----------------------------------|
|  | n   | Cost – mean | Cost – standard deviation | Cost – co-efficient of variation |
| <b>A01 Did not wait</b>  |   |             |                           |                                  |
| A01_A  | 1,758   | \$247       | \$324                     | 1.31                             |
| <b>A02A Return Visit, planned, planned Triage=1,2</b>          |   |             |                           |                                  |
| A02A_A   | 8   | \$1,126     | \$607                     | 0.54                             |
| <b>A02B Return Visit, planned, planned Triage=3,4,5</b>        |   |             |                           |                                  |
| A02B_A   | 256   | \$450       | \$287                     | 0.64                             |
| <b>A03 Dead on arrival</b>                                     |   |             |                           |                                  |
| A03_A  | 91  | \$173       | \$226                     | 1.31                             |
| <b>A04A Referred to another hospital, planned Triage=1,2</b>   |   |             |                           |                                  |
| A04A_A   | 243   | \$1,352     | \$1,034                   | 0.76                             |
| <b>A04B Referred to another hospital, planned Triage=3,4,5</b> |   |             |                           |                                  |
| A04B_A   | 453   | \$971       | \$673                     | 0.69                             |
| <b>A05 Died in ED</b>  |   |             |                           |                                  |
| A05_A  | 24  | \$1,885     | \$2,049                   | 1.09                             |
| <b>A06A Left at own risk, planned Triage=1,2</b>               |   |             |                           |                                  |
| A06A_A   | 84  | \$867       | \$490                     | 0.56                             |
| <b>A06B Left at own risk, planned Triage=3,4,5</b>             |   |             |                           |                                  |
| A06B_A   | 448   | \$526       | \$400                     | 0.76                             |
| <b>B63 Dementia/ chronic brain syndrome</b>                    |   |             |                           |                                  |
| B63_A  | 10  | \$1,535     | \$905                     | 0.59                             |
| B63_B  | 14  | \$1,035     | \$508                     | 0.49                             |
| B63_C  | 11  | \$756       | \$392                     | 0.52                             |
| <b>B64 Delirium/ confusion/ acute encephalopathy</b>           |   |             |                           |                                  |
| B64_A  | 168   | \$1,359     | \$558                     | 0.41                             |
| <b>B69 TIA and precerebral occlusion</b>                       |   |             |                           |                                  |
| B69_A  | 110   | \$1,153     | \$502                     | 0.44                             |

| AECC end classes   | Statistics from the <i>Emergency care costing study</i> |             |                           |                                  |
|--|---|-------------|---------------------------|----------------------------------|
|  | n   | Cost – mean | Cost – standard deviation | Cost – co-efficient of variation |
| <b>B70 Stroke &amp; other cerebrovascular disorders</b>      |   |             |                           |                                  |
| B70_A  | 108   | \$1,680     | \$1,260                   | 0.75                             |
| B70_B  | 35  | \$1,119     | \$506                     | 0.45                             |
| <b>B72 CNS infection/ inflammation</b>                       |   |             |                           |                                  |
| B72_A  | 12  | \$1,599     | \$738                     | 0.46                             |
| <b>B81 Disorders of the nervous system, other</b>            |   |             |                           |                                  |
| B81_A  | 32  | \$1,609     | \$507                     | 0.32                             |
| B81_B  | 349   | \$1,180     | \$595                     | 0.5                              |
| B81_C  | 980   | \$742       | \$509                     | 0.69                             |
| <b>C633 Eye disorder, other</b>                              |   |             |                           |                                  |
| C633_A   | 52  | \$1,003     | \$695                     | 0.69                             |
| C633_B   | 465   | \$414       | \$246                     | 0.6                              |
| <b>D66 Ear, nose, mouth and throat disorders, other</b>      |   |             |                           |                                  |
| D66_A  | 39  | \$880       | \$478                     | 0.54                             |
| D66_B  | 88  | \$639       | \$248                     | 0.39                             |
| D66_C  | 369   | \$381       | \$191                     | 0.5                              |
| <b>D671 Teeth and supporting structures disorders, other</b> |   |             |                           |                                  |
| D671_A   | 30  | \$899       | \$381                     | 0.42                             |
| D671_B   | 217   | \$355       | \$170                     | 0.48                             |
| <b>E61 Major respiratory diagnosis</b>                       |   |             |                           |                                  |
| E61_A  | 31  | \$1,490     | \$615                     | 0.41                             |
| E61_B  | 37  | \$1,139     | \$568                     | 0.5                              |
| <b>E623 Upper respiratory tract infection (URTI), other</b>  |   |             |                           |                                  |
| E623_A   | 315   | \$691       | \$373                     | 0.54                             |
| E623_B   | 721   | \$384       | \$204                     | 0.53                             |
| <b>E65 Chronic obstructive airways disease</b>               |   |             |                           |                                  |
| E65_A  | 268   | \$1,140     | \$708                     | 0.62                             |
| <b>E69 Asthma/ wheeze/ croup/ airway infection</b>           |   |             |                           |                                  |
| E69_A  | 536   | \$809       | \$388                     | 0.48                             |
| E69_B  | 619   | \$484       | \$216                     | 0.45                             |
| <b>E753 Respiratory disorder, other</b>                      |   |             |                           |                                  |
| E753_A   | 831   | \$1,120     | \$531                     | 0.47                             |
| E753_B   | 775   | \$638       | \$343                     | 0.54                             |
| <b>F60 Acute coronary syndrome</b>                           |   |             |                           |                                  |
| F60_A  | 309   | \$1,028     | \$608                     | 0.59                             |
| <b>F62 Heart failure and shock</b>                           |   |             |                           |                                  |
| F62_A  | 86  | \$1,438     | \$561                     | 0.39                             |
| F62_B  | 147   | \$1,115     | \$531                     | 0.48                             |
| <b>F74 Chest pain</b>  |   |             |                           |                                  |
| F74_A  | 496   | \$1,072     | \$481                     | 0.45                             |
| F74_B  | 1,275   | \$779       | \$362                     | 0.46                             |
| <b>F75 Circulatory disorder, other</b>                       |   |             |                           |                                  |
| F75_A  | 146   | \$1,486     | \$1,020                   | 0.69                             |
| F75_B  | 525   | \$906       | \$507                     | 0.56                             |
| F75_C  | 432   | \$669       | \$334                     | 0.5                              |
| <b>F76 Arrhythmia and cardiac arrest</b>                     |   |             |                           |                                  |
| F76_A  | 152   | \$1,178     | \$527                     | 0.45                             |
| F76_B  | 210   | \$828       | \$353                     | 0.43                             |
| <b>G61 Gastrointestinal haemorrhage</b>                      |   |             |                           |                                  |
| G61_A  | 92  | \$1,268     | \$626                     | 0.49                             |
| G61_B  | 129   | \$687       | \$382                     | 0.56                             |
| <b>G65 Gastrointestinal obstruction</b>                      |   |             |                           |                                  |
| G65_A  | 110   | \$1,149     | \$518                     | 0.45                             |
| <b>G661 Gastrointestinal peritonitis/ perforation</b>        |   |             |                           |                                  |
| G661_A   | 103   | \$1,213     | \$691                     | 0.57                             |
| G661_B   | 317   | \$822       | \$400                     | 0.49                             |
| <b>G662 Abdominal pain</b>                                   |   |             |                           |                                  |
| G662_A   | 889   | \$972       | \$499                     | 0.51                             |
| G662_B   | 1,106   | \$661       | \$320                     | 0.48                             |
| <b>G67 Oesophagitis and gastroenteritis</b>                  |   |             |                           |                                  |

| AECC end classes   | Statistics from the <i>Emergency care costing study</i> |             |                           |                                  |
|--|---|-------------|---------------------------|----------------------------------|
|  | n   | Cost – mean | Cost – standard deviation | Cost – co-efficient of variation |
| G67_A  | 305   | \$841       | \$493                     | 0.59                             |
| G67_B  | 354   | \$483       | \$253                     | 0.52                             |
| <b>G702 Digestive system disorders, other</b>                                    |   |             |                           |                                  |
| G702_A   | 186   | \$1,023     | \$545                     | 0.53                             |
| G702_B   | 426   | \$751       | \$389                     | 0.52                             |
| G702_C   | 615   | \$519       | \$284                     | 0.55                             |
| <b>H63 Disorders of liver</b>  |   |             |                           |                                  |
| H63_A  | 8   | \$2,009     | \$762                     | 0.38                             |
| H63_B  | 56  | \$1,043     | \$419                     | 0.4                              |
| H63_C  | 19  | \$577       | \$250                     | 0.43                             |
| <b>H64 Disorder of the biliary tract</b>   |   |             |                           |                                  |
| H64_A  | 27  | \$1,362     | \$552                     | 0.4                              |
| H64_B  | 199   | \$774       | \$381                     | 0.49                             |
| <b>I01 Major injury</b>  |   |             |                           |                                  |
| I01_A  | 256   | \$1,219     | \$783                     | 0.64                             |
| I01_B  | 681   | \$461       | \$394                     | 0.86                             |
| <b>I02 Fractures of neck of femur</b>  |   |             |                           |                                  |
| I02_A  | 58  | \$1,512     | \$507                     | 0.34                             |
| I02_B  | 67  | \$1,235     | \$379                     | 0.31                             |
| I02_C  | 41  | \$889       | \$370                     | 0.42                             |
| <b>I03 Fracture of shoulder and lower leg, dislocation, sprain and strain</b>    |   |             |                           |                                  |
| I03_A  | 180   | \$1,206     | \$599                     | 0.5                              |
| I03_B  | 266   | \$873       | \$556                     | 0.64                             |
| I03_C  | 792   | \$496       | \$238                     | 0.48                             |
| <b>I04 Injuries, fractures (forearm, wrist, ankle, foot), and other injuries</b> |   |             |                           |                                  |
| I04_A  | 301   | \$911       | \$596                     | 0.65                             |
| I04_B  | 2,116   | \$482       | \$214                     | 0.44                             |
| <b>I05 Injury, other</b>   |   |             |                           |                                  |
| I05_A  | 171   | \$1,343     | \$678                     | 0.5                              |
| I05_B  | 329   | \$776       | \$437                     | 0.56                             |
| I05_C  | 693   | \$456       | \$259                     | 0.57                             |
| <b>I06 Minor injury</b>  |   |             |                           |                                  |
| I06_A  | 16  | \$1,179     | \$860                     | 0.73                             |
| I06_B  | 416   | \$891       | \$517                     | 0.58                             |
| I06_C  | 1772  | \$427       | \$214                     | 0.5                              |
| <b>I71 Musculotendinous disorders, other</b>                                     |   |             |                           |                                  |
| I71_A  | 761   | \$915       | \$601                     | 0.66                             |
| I71_B  | 1,241   | \$484       | \$331                     | 0.68                             |
| <b>I85 Complications of surgical and medical care</b>                            |   |             |                           |                                  |
| I85_A  | 105   | \$801       | \$356                     | 0.44                             |
| I85_B  | 211   | \$528       | \$268                     | 0.51                             |
| I85_C  | 45  | \$323       | \$170                     | 0.53                             |
| <b>J64 Cellulitis/ skin infection</b>  |   |             |                           |                                  |
| J64_A  | 112   | \$1,163     | \$544                     | 0.47                             |
| J64_B  | 946   | \$554       | \$293                     | 0.53                             |
| <b>J67 Skin disorders, other</b>   |   |             |                           |                                  |
| J67_A  | 144   | \$748       | \$404                     | 0.54                             |
| J67_B  | 511   | \$417       | \$260                     | 0.62                             |
| <b>K60 Diabetes</b>  |   |             |                           |                                  |
| K60_A  | 54  | \$1,371     | \$856                     | 0.62                             |
| K60_B  | 46  | \$708       | \$375                     | 0.53                             |
| <b>K62 Miscellaneous metabolic disorders</b>                                     |   |             |                           |                                  |
| K62_A  | 181   | \$1,143     | \$447                     | 0.39                             |
| K62_B  | 191   | \$685       | \$358                     | 0.52                             |
| <b>L60 Renal failure</b>   |   |             |                           |                                  |
| L60_A  | 50  | \$1,316     | \$678                     | 0.52                             |
| L60_B  | 36  | \$856       | \$456                     | 0.53                             |
| <b>L672 Kidney and urinary tract disorder, other</b>                             |   |             |                           |                                  |
| L672_A   | 645   | \$915       | \$447                     | 0.49                             |
| L672_B   | 430   | \$604       | \$329                     | 0.54                             |

| AECC end classes   | Statistics from the <i>Emergency care costing study</i> |             |                           |                                  |
|--|---|-------------|---------------------------|----------------------------------|
|  | n   | Cost – mean | Cost – standard deviation | Cost – co-efficient of variation |
| <b>M64 Male reproductive system disorders</b>                            |   |             |                           |                                  |
| M64_A  | 168   | \$623       | \$343                     | 0.55                             |
| <b>N62 Menstrual and other female reproductive system disorders</b>      |   |             |                           |                                  |
| N62_A  | 390   | \$702       | \$319                     | 0.45                             |
| <b>O61 Postpartum and post abortion</b>                                  |   |             |                           |                                  |
| O61_A  | 106   | \$701       | \$368                     | 0.52                             |
| <b>O66 Antenatal and other obstetric presentation</b>                    |   |             |                           |                                  |
| O66_A  | 320   | \$596       | \$279                     | 0.47                             |
| <b>P68 Perinatal disorders</b>   |   |             |                           |                                  |
| P68_A  | 17  | \$827       | \$357                     | 0.43                             |
| P68_B  | 18  | \$452       | \$145                     | 0.32                             |
| <b>Q60 Reticuloendothelial and immunity disorder</b>                     |   |             |                           |                                  |
| Q60_A  | 51  | \$951       | \$391                     | 0.41                             |
| Q60_B  | 29  | \$444       | \$156                     | 0.35                             |
| <b>Q61 Red blood cell disorders</b>                                      |   |             |                           |                                  |
| Q61_A  | 110   | \$1,167     | \$571                     | 0.49                             |
| Q61_B  | 12  | \$632       | \$222                     | 0.35                             |
| <b>Q62 Haemostasis</b>   |   |             |                           |                                  |
| Q62_A  | 12  | \$969       | \$448                     | 0.46                             |
| Q62_B  | 14  | \$831       | \$452                     | 0.54                             |
| Q62_C  | 7   | \$471       | \$150                     | 0.32                             |
| <b>R62 Neoplastic disorders</b>  |   |             |                           |                                  |
| R62_A  | 22  | \$1,565     | \$2,007                   | 1.28                             |
| R62_B  | 104   | \$900       | \$486                     | 0.54                             |
| <b>T60 Septicaemia</b>   |   |             |                           |                                  |
| T60_A  | 72  | \$1,542     | \$660                     | 0.43                             |
| T60_B  | 15  | \$1,222     | \$453                     | 0.37                             |
| <b>T62 Fever of unknown origin</b>                                       |   |             |                           |                                  |
| T62_A  | 132   | \$1,190     | \$609                     | 0.51                             |
| T62_B  | 226   | \$677       | \$591                     | 0.87                             |
| <b>T63 Viral illness</b>   |   |             |                           |                                  |
| T63_A  | 268   | \$711       | \$292                     | 0.41                             |
| T63_B  | 637   | \$419       | \$195                     | 0.47                             |
| <b>T64 Infectious and parasitic disease, other</b>                       |   |             |                           |                                  |
| T64_A  | 57  | \$840       | \$433                     | 0.52                             |
| T64_B  | 52  | \$478       | \$239                     | 0.5                              |
| <b>U62 Psychosis</b>   |   |             |                           |                                  |
| U62_A  | 15  | \$1,433     | \$714                     | 0.5                              |
| U62_B  | 140   | \$819       | \$493                     | 0.6                              |
| <b>U69 Mental and behavioural disorder, other</b>                        |   |             |                           |                                  |
| U69_A  | 145   | \$1,076     | \$602                     | 0.56                             |
| U69_B*   | 261   | \$803       | \$486                     | 0.6                              |
| U69_C*   | 420   | \$711       | \$491                     | 0.69                             |
| U69_D  | 140   | \$517       | \$313                     | 0.61                             |
| <b>V69 Alcohol and/ or drug related mental and behavioural disorders</b> |   |             |                           |                                  |
| V69_A  | 69  | \$1,211     | \$543                     | 0.45                             |
| V69_B  | 353   | \$796       | \$416                     | 0.52                             |
| V69_C  | 105   | \$428       | \$229                     | 0.53                             |
| <b>X61 Allergic reactions</b>  |   |             |                           |                                  |
| X61_A  | 92  | \$656       | \$288                     | 0.44                             |
| X61_B  | 96  | \$379       | \$186                     | 0.49                             |
| <b>X62 Poisoning</b>   |   |             |                           |                                  |
| X62_A  | 13  | \$1,933     | \$781                     | 0.4                              |
| X62_B  | 236   | \$992       | \$482                     | 0.49                             |
| X62_C  | 120   | \$494       | \$242                     | 0.49                             |
| <b>X64 Abuse and neglect</b>   |   |             |                           |                                  |
| X64_A  | 55  | \$1,153     | \$429                     | 0.37                             |
| X64_B  | 68  | \$477       | \$302                     | 0.63                             |
| <b>Y62 Burns</b>   |   |             |                           |                                  |
| Y62_A  | 9   | \$985       | \$132                     | 0.13                             |

| AECC end classes                                   | Statistics from the <i>Emergency care costing study</i> |             |                           |                                  |
|--|---|-------------|---------------------------|----------------------------------|
|  | n   | Cost – mean | Cost – standard deviation | Cost – co-efficient of variation |
| Y62_B*   | 35  | \$639       | \$253                     | 0.4                              |
| Y62_C*   | 16  | \$593       | \$244                     | 0.41                             |
| Y62_D  | 125   | \$380       | \$161                     | 0.42                             |
| <b>Z611 Falls risk</b>                             |   |             |                           |                                  |
| Z611_A   | 308   | \$868       | \$634                     | 0.73                             |
| <b>Z612 Pain syndrome</b>                          |   |             |                           |                                  |
| Z612_A   | 159   | \$696       | \$379                     | 0.54                             |
| <b>Z613 Signs and symptoms, other</b>              |   |             |                           |                                  |
| Z613_A   | 480   | \$783       | \$495                     | 0.63                             |
| <b>Z63 Forensic examination</b>                    |   |             |                           |                                  |
| Z63_A  | 365   | \$974       | \$620                     | 0.64                             |
| <b>Z64 Other factors influencing health status</b> |   |             |                           |                                  |
| Z64_A  | 271   | \$876       | \$442                     | 0.51                             |
| Z64_B  | 800   | \$377       | \$264                     | 0.7                              |

\* Although the average costs between the end classes marked are similar, they are being retained as separate classes due to the differences in the dispersion of costs combined with very high volumes represented by these classes when applied to national data. The volumes of activity are shown in the Chapter 5 of this document, and the cost dispersions are below.

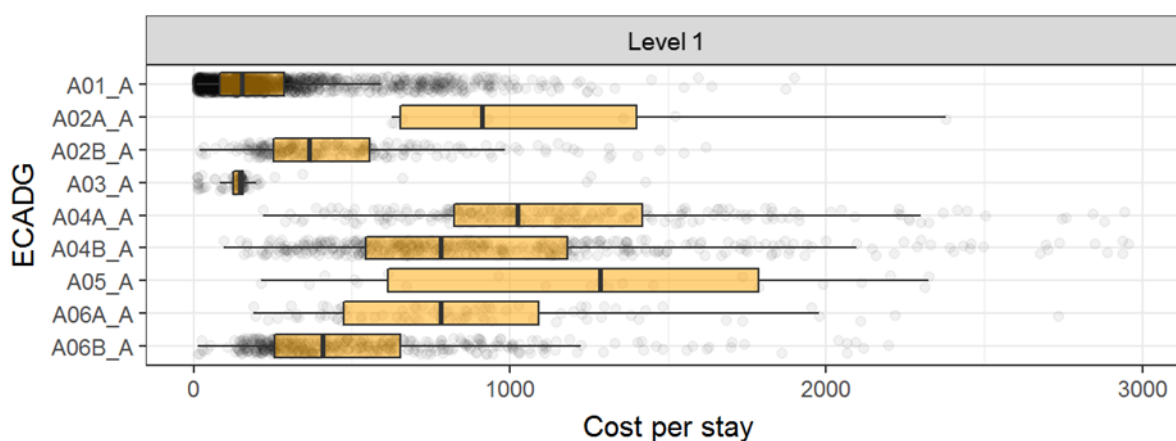

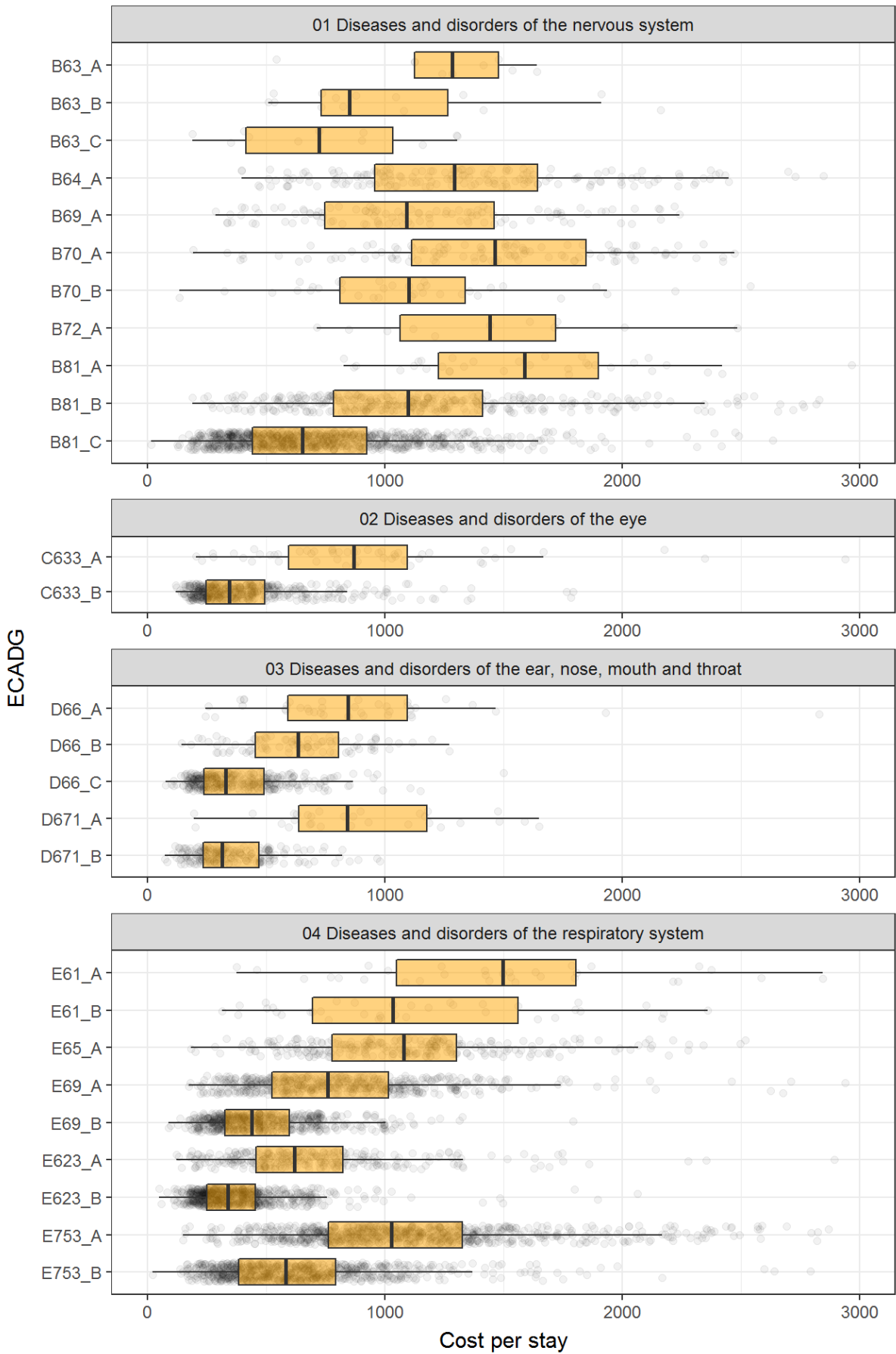



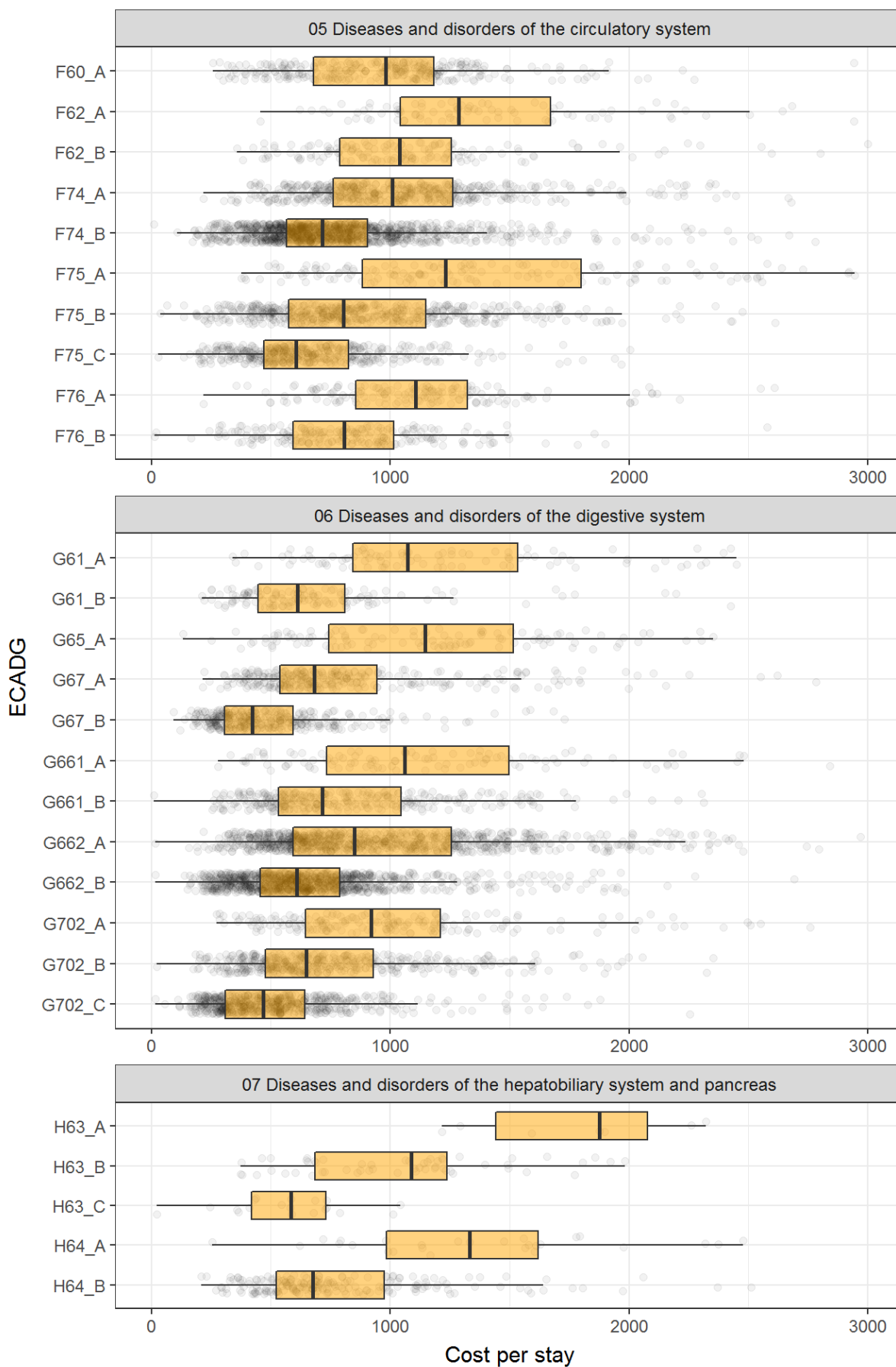

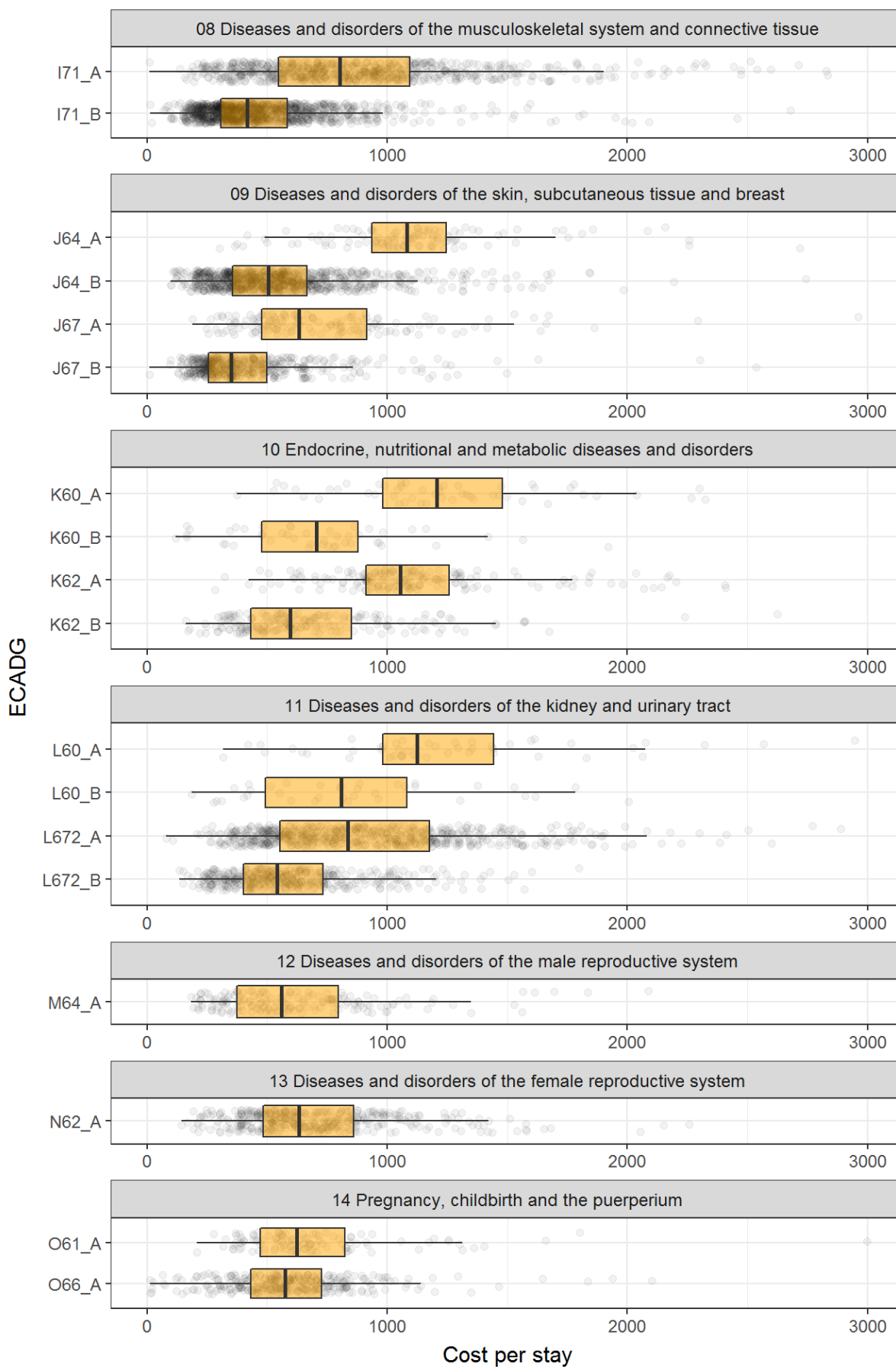

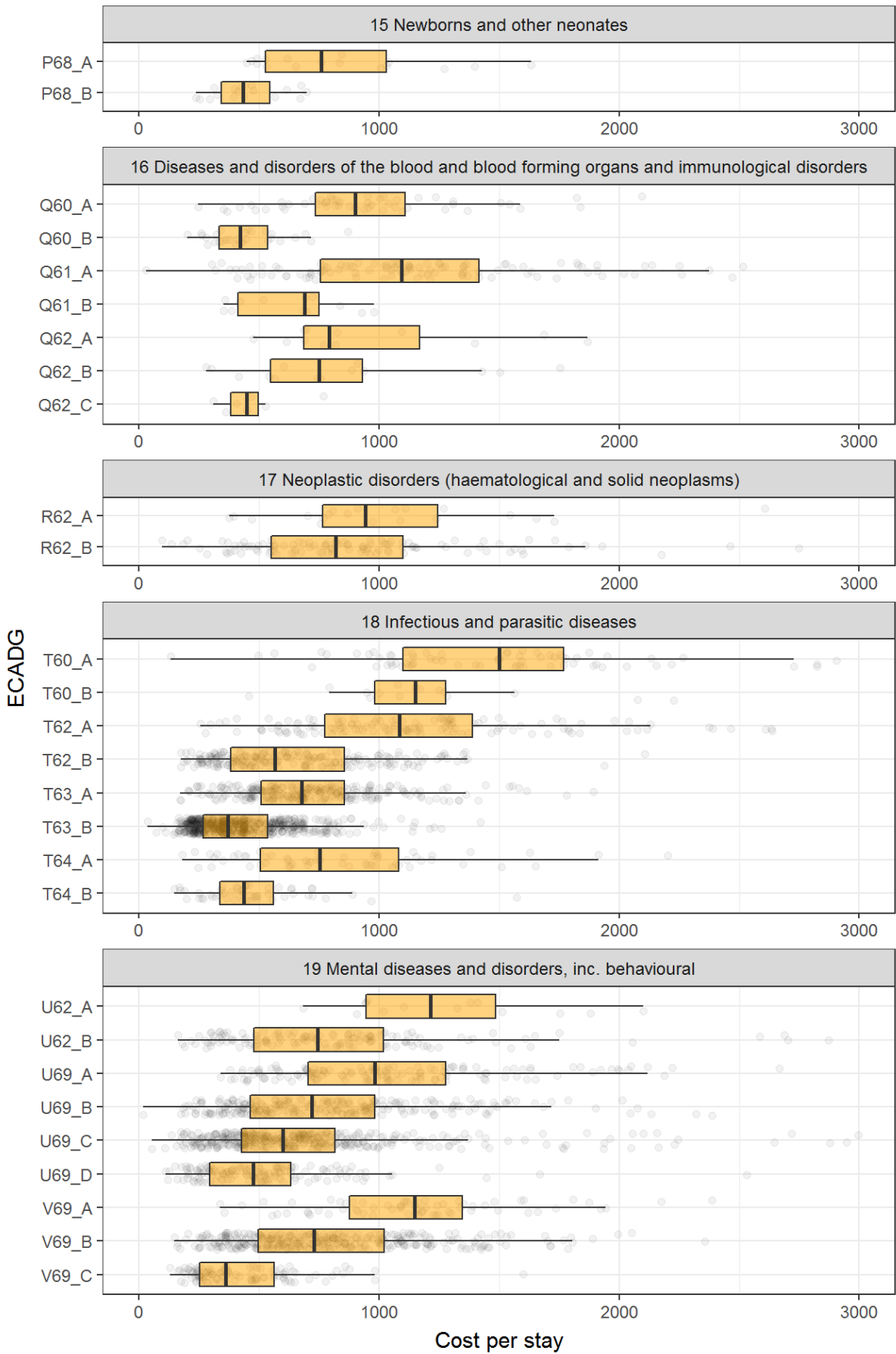

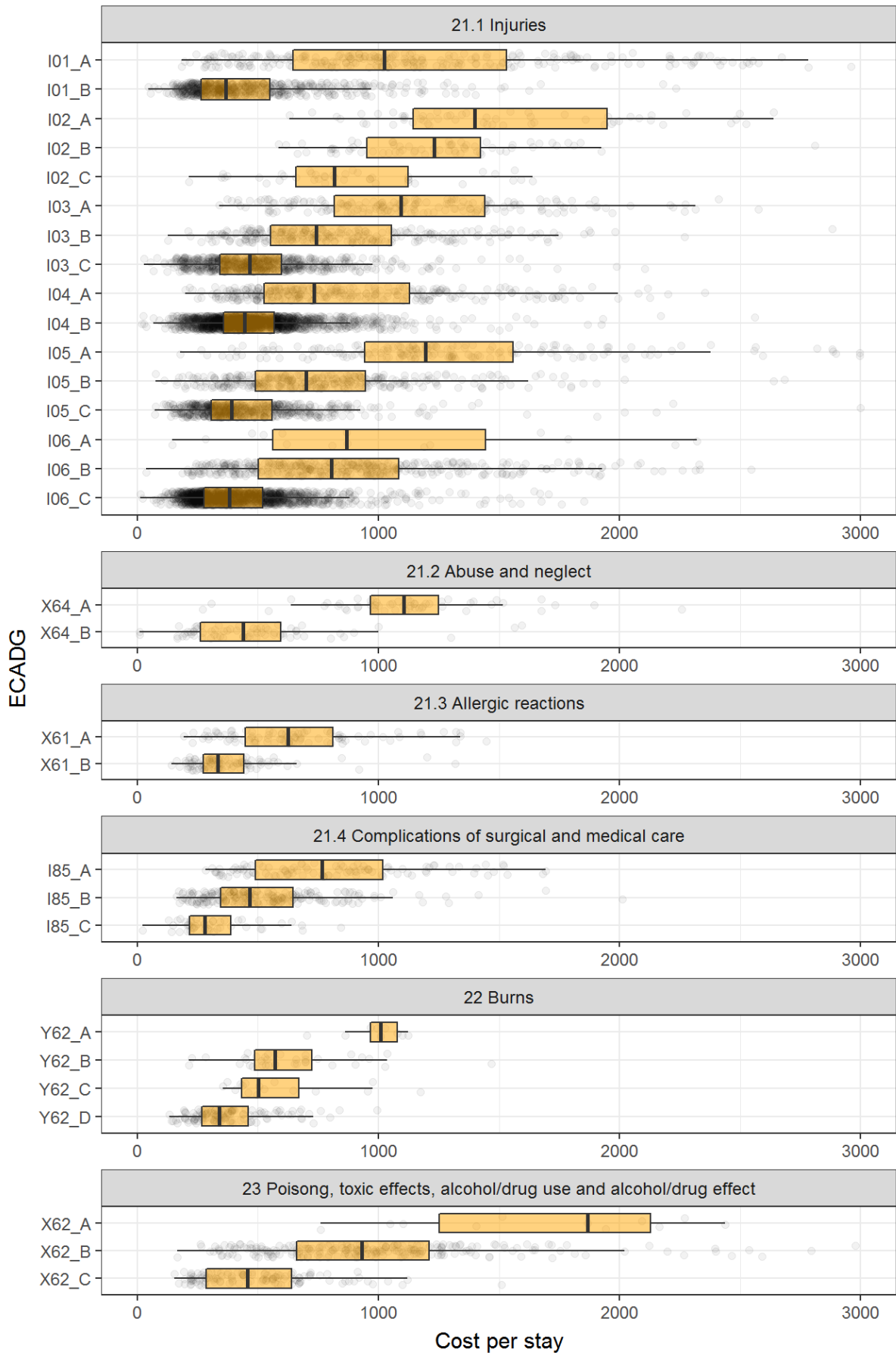

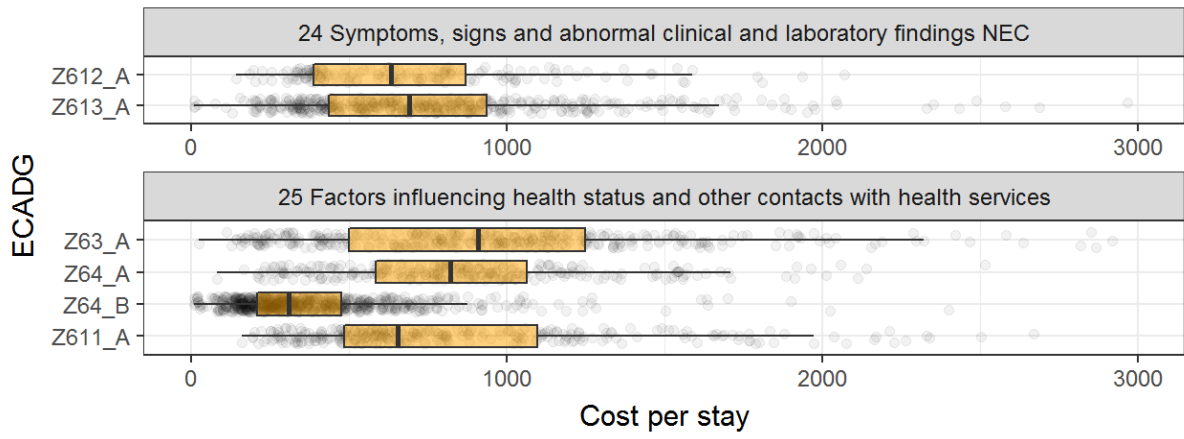

# Indicative national volumes by end class

This Chapter shows the number of stays assigned to each draft end class using data from the National Hospital Cost Data Collection (NHCDC) for 2014-15. The purpose is to give an idea of the volumes within each class when applied to the national data. The activity data was taken from the NHCDC rather than the Non-Admitted Patient Emergency Department Care (NAPEDC) National Minimum Data Set (NMDS) as analyses for this study have focussed on cost.

| AECC class   | No. of stays (NHCDC 2014-15) | AECC within class % | Overall % |
|--|------------------------------|---------------------|-----------|
| <b>A01 Did not wait</b>  |                              |                     |           |
| A01_A  | 243,576                      | 100.00              | 3.84      |
| <b>A02A Return Visit, planned, Triage=1,2</b>                  |                              |                     |           |
| A02A_A   | 651                          | 100.00              | 0.01      |
| <b>A02B Return Visit, planned, Triage=3,4,5</b>                |                              |                     |           |
| A02B_A   | 107,329                      | 100.00              | 1.69      |
| <b>A03 Dead on arrival</b>                                     |                              |                     |           |
| A03_A  | 4,807                        | 100.00              | 0.08      |
| <b>A04A Referred to another hospital, planned Triage=1,2</b>   |                              |                     |           |
| A04A_A   | 27,112                       | 100.00              | 0.43      |
| <b>A04B Referred to another hospital, planned Triage=3,4,5</b> |                              |                     |           |
| A04B_A   | 62,127                       | 100.00              | 0.98      |
| <b>A05 Died in ED</b>  |                              |                     |           |
| A05_A  | 2,542                        | 100.00              | 0.04      |
| <b>A06A Left at own risk, planned Triage=1,2</b>               |                              |                     |           |
| A06A_A   | 9,574                        | 100.00              | 0.15      |
| <b>A06B Left at own risk, planned Triage=3,4,5</b>             |                              |                     |           |
| A06B_A   | 104,889                      | 100.00              | 1.65      |
| <b>B63 Dementia/ chronic brain syndrome</b>                    |                              |                     |           |
| B63_A  | 1,372                        | 31.08               | 0.02      |
| B63_B  | 1,553                        | 35.18               | 0.02      |
| B63_C  | 1,490                        | 33.75               | 0.02      |
| <b>B64 Delirium/ confusion/ acute encephalopathy</b>           |                              |                     |           |
| B64_A  | 24,228                       | 100.00              | 0.38      |
| <b>B69 TIA and precerebral occlusion</b>                       |                              |                     |           |
| B69_A  | 16,590                       | 100.00              | 0.26      |
| <b>B70 Stroke &amp; other cerebrovascular disorders</b>        |                              |                     |           |
| B70_A  | 17,594                       | 75.79               | 0.28      |
| B70_B  | 5,619                        | 24.21               | 0.09      |
| <b>B72 CNS infection/ inflammation</b>                         |                              |                     |           |
| B72_A  | 2,656                        | 100.00              | 0.04      |
| <b>B81 Disorders of the nervous system, other</b>              |                              |                     |           |
| B81_A  | 2,454                        | 1.23                | 0.04      |
| B81_B  | 49,483                       | 24.86               | 0.78      |
| B81_C  | 147,089                      | 73.90               | 2.32      |
| <b>C633 Eye disorder, other</b>                                |                              |                     |           |
| C633_A   | 6,957                        | 7.34                | 0.11      |
| C633_B   | 87,829                       | 92.66               | 1.38      |

| AECC class   | No. of stays (NHCDC 2014-15) | AECC within class % | Overall % |
|--|------------------------------|---------------------|-----------|
| <b>D66 Ear, nose, mouth and throat disorders, other</b>      |                              |                     |           |
| D66_A  | 5,592                        | 5.22                | 0.09      |
| D66_B  | 13,130                       | 12.26               | 0.21      |
| D66_C  | 88,338                       | 82.51               | 1.39      |
| <b>D671 Teeth and supporting structures disorders, other</b> |                              |                     |           |
| D671_A   | 3,726                        | 8.86                | 0.06      |
| D671_B   | 38,351                       | 91.14               | 0.60      |
| <b>E61 Major respiratory diagnosis</b>                       |                              |                     |           |
| E61_A  | 3,071                        | 32.61               | 0.05      |
| E61_B  | 6,346                        | 67.39               | 0.10      |
| <b>E623 Upper respiratory tract infection (URTI), other</b>  |                              |                     |           |
| E623_A   | 45,761                       | 26.10               | 0.72      |
| E623_B   | 129,561                      | 73.90               | 2.04      |
| <b>E65 Chronic obstructive airways disease</b>               |                              |                     |           |
| E65_A  | 36,382                       | 100.00              | 0.57      |
| <b>E69 Asthma/ wheeze/ croup/ airway infection</b>           |                              |                     |           |
| E69_A  | 73,494                       | 51.69               | 1.16      |
| E69_B  | 68,680                       | 48.31               | 1.08      |
| <b>E753 Respiratory disorder, other</b>                      |                              |                     |           |
| E753_A   | 105,334                      | 47.46               | 1.66      |
| E753_B   | 116,614                      | 52.54               | 1.84      |
| <b>F60 Acute coronary syndrome</b>                           |                              |                     |           |
| F60_A  | 77,455                       | 100.00              | 1.22      |
| <b>F62 Heart failure and shock</b>                           |                              |                     |           |
| F62_A  | 10,423                       | 33.45               | 0.16      |
| F62_B  | 20,737                       | 66.55               | 0.33      |
| <b>F74 Chest pain</b>  |                              |                     |           |
| F74_A  | 48,540                       | 22.61               | 0.77      |
| F74_B  | 166,139                      | 77.39               | 2.62      |
| <b>F75 Circulatory disorder, other</b>                       |                              |                     |           |
| F75_A  | 13,303                       | 8.52                | 0.21      |
| F75_B  | 78,321                       | 50.18               | 1.23      |
| F75_C  | 64,448                       | 41.29               | 1.02      |
| <b>F76 Arrhythmia and cardiac arrest</b>                     |                              |                     |           |
| F76_A  | 27,864                       | 44.72               | 0.44      |
| F76_B  | 34,450                       | 55.28               | 0.54      |
| <b>G61 Gastrointestinal haemorrhage</b>                      |                              |                     |           |
| G61_A  | 11,213                       | 44.26               | 0.18      |
| G61_B  | 14,120                       | 55.74               | 0.22      |
| <b>G65 Gastrointestinal obstruction</b>                      |                              |                     |           |
| G65_A  | 17,472                       | 100.00              | 0.28      |
| <b>G661 Gastrointestinal peritonitis/ perforation</b>        |                              |                     |           |
| G661_A   | 18,013                       | 26.17               | 0.28      |
| G661_B   | 50,811                       | 73.83               | 0.80      |
| <b>G662 Abdominal pain</b>                                   |                              |                     |           |
| G662_A   | 127,795                      | 45.50               | 2.01      |
| G662_B   | 153,062                      | 54.50               | 2.41      |
| <b>G67 Oesophagitis and gastroenteritis</b>                  |                              |                     |           |
| G67_A  | 54,595                       | 42.55               | 0.86      |
| G67_B  | 73,725                       | 57.45               | 1.16      |
| <b>G702 Digestive system disorders, other</b>                |                              |                     |           |
| G702_A   | 25,206                       | 12.56               | 0.40      |
| G702_B   | 62,757                       | 31.28               | 0.99      |
| G702_C   | 112,668                      | 56.16               | 1.78      |
| <b>H63 Disorders of liver</b>                                |                              |                     |           |
| H63_A  | 622                          | 5.49                | 0.01      |

| AECC class   | No. of stays (NHCDC 2014-15) | AECC within class % | Overall % |
|--|------------------------------|---------------------|-----------|
| H63_B  | 7,239                        | 63.89               | 0.11      |
| H63_C  | 3,469                        | 30.62               | 0.05      |
| <b>H64 Disorder of the biliary tract</b>   |                              |                     |           |
| H64_A  | 3,651                        | 10.74               | 0.06      |
| H64_B  | 30,345                       | 89.26               | 0.48      |
|  |                              |                     |           |
| <b>I01 Major injury</b>  |                              |                     |           |
| I01_A  | 41,626                       | 28.77               | 0.66      |
| I01_B  | 103,072                      | 71.23               | 1.62      |
| <b>I02 Fractures of neck of femur</b>  |                              |                     |           |
| I02_A  | 7,575                        | 31.94               | 0.12      |
| I02_B  | 11,002                       | 46.38               | 0.17      |
| I02_C  | 5,143                        | 21.68               | 0.08      |
| <b>I03 Fracture of shoulder and lower leg, dislocation, sprain and strain</b>    |                              |                     |           |
| I03_A  | 31,048                       | 14.62               | 0.49      |
| I03_B  | 45,791                       | 21.56               | 0.72      |
| I03_C  | 135,552                      | 63.82               | 2.14      |
| <b>I04 Injuries, fractures (forearm, wrist, ankle, foot), and other injuries</b> |                              |                     |           |
| I04_A  | 54,483                       | 13.18               | 0.86      |
| I04_B  | 358,867                      | 86.82               | 5.66      |
| <b>I05 Injury, other</b>   |                              |                     |           |
| I05_A  | 20,084                       | 9.39                | 0.32      |
| I05_B  | 52,254                       | 24.43               | 0.82      |
| I05_C  | 141,553                      | 66.18               | 2.23      |
| <b>I06 Minor injury</b>  |                              |                     |           |
| I06_A  | 1,499                        | 0.40                | 0.02      |
| I06_B  | 56,431                       | 15.13               | 0.89      |
| I06_C  | 315,076                      | 84.47               | 4.97      |
|  |                              |                     |           |
| <b>I71 Musculotendinous disorders, other</b>                                     |                              |                     |           |
| I71_A  | 88,638                       | 34.02               | 1.40      |
| I71_B  | 171,925                      | 65.98               | 2.71      |
| <b>I85 Complications of surgical and medical care</b>                            |                              |                     |           |
| I85_A  | 13,660                       | 22.43               | 0.22      |
| I85_B  | 37,104                       | 60.92               | 0.58      |
| I85_C  | 10,138                       | 16.65               | 0.16      |
| <b>J64 Cellulitis/ skin infection</b>  |                              |                     |           |
| J64_A  | 12,422                       | 8.42                | 0.20      |
| J64_B  | 135,098                      | 91.58               | 2.13      |
| <b>J67 Skin disorders, other</b>   |                              |                     |           |
| J67_A  | 18,100                       | 16.79               | 0.29      |
| J67_B  | 89,717                       | 83.21               | 1.41      |
| <b>K60 Diabetes</b>  |                              |                     |           |
| K60_A  | 5,643                        | 48.70               | 0.09      |
| K60_B  | 5,945                        | 51.30               | 0.09      |
| <b>K62 Miscellaneous metabolic disorders</b>                                     |                              |                     |           |
| K62_A  | 17,107                       | 41.50               | 0.27      |
| K62_B  | 24,116                       | 58.50               | 0.38      |
| <b>L60 Renal failure</b>   |                              |                     |           |
| L60_A  | 8,718                        | 67.47               | 0.14      |
| L60_B  | 4,203                        | 32.53               | 0.07      |
| <b>L672 Kidney and urinary tract disorder, other</b>                             |                              |                     |           |
| L672_A   | 101,794                      | 54.23               | 1.60      |
| L672_B   | 85,914                       | 45.77               | 1.35      |
| <b>M64 Male reproductive system disorders</b>                                    |                              |                     |           |
| M64_A  | 23,525                       | 100.00              | 0.37      |
| <b>N62 Menstrual and other female reproductive system disorders</b>              |                              |                     |           |



| AECC class   | No. of stays (NHCDC 2014-15) | AECC within class % | Overall % |
|--|------------------------------|---------------------|-----------|
| N62_A  | 57,761                       | 100.00              | 0.91      |
| <b>O61 Postpartum and post abortion</b>                                  |                              |                     |           |
| O61_A  | 22,789                       | 100.00              | 0.36      |
| <b>O66 Antenatal and other obstetric presentation</b>                    |                              |                     |           |
| O66_A  | 70,883                       | 100.00              | 1.12      |
| <b>P68 Perinatal disorders</b>   |                              |                     |           |
| P68_A  | 1,520                        | 29.37               | 0.02      |
| P68_B  | 3,656                        | 70.63               | 0.06      |
| <b>Q60 Reticuloendothelial and immunity disorder</b>                     |                              |                     |           |
| Q60_A  | 7,579                        | 60.40               | 0.12      |
| Q60_B  | 4,968                        | 39.60               | 0.08      |
| <b>Q61 Red blood cell disorders</b>                                      |                              |                     |           |
| Q61_A  | 13,392                       | 79.36               | 0.21      |
| Q61_B  | 3,483                        | 20.64               | 0.05      |
| <b>Q62 Haemostasis</b>   |                              |                     |           |
| Q62_A  | 2,445                        | 47.07               | 0.04      |
| Q62_B  | 1,800                        | 34.66               | 0.03      |
| Q62_C  | 949                          | 18.27               | 0.01      |
| <b>R62 Neoplastic disorders</b>  |                              |                     |           |
| R62_A  | 2371                         | 11.83               | 0.04      |
| R62_B  | 17678                        | 88.17               | 0.28      |
| <b>T60 Septicaemia</b>   |                              |                     |           |
| T60_A  | 12,553                       | 85.67               | 0.20      |
| T60_B  | 2,099                        | 14.33               | 0.03      |
| <b>T62 Fever of unknown origin</b>                                       |                              |                     |           |
| T62_A  | 16,301                       | 37.44               | 0.26      |
| T62_B  | 27,241                       | 62.56               | 0.43      |
| <b>T63 Viral illness</b>   |                              |                     |           |
| T63_A  | 40,043                       | 27.62               | 0.63      |
| T63_B  | 104,918                      | 72.38               | 1.65      |
| <b>T64 Infectious and parasitic disease, other</b>                       |                              |                     |           |
| T64_A  | 6,168                        | 52.73               | 0.10      |
| T64_B  | 5,530                        | 47.27               | 0.09      |
| <b>U62 Psychosis</b>   |                              |                     |           |
| U62_A  | 1,179                        | 5.36                | 0.02      |
| U62_B  | 20,837                       | 94.64               | 0.33      |
| <b>U69 Mental and behavioural disorder, other</b>                        |                              |                     |           |
| U69_A  | 18,727                       | 11.91               | 0.30      |
| U69_B  | 43,993                       | 27.97               | 0.69      |
| U69_C  | 57,475                       | 36.54               | 0.91      |
| U69_D  | 37,081                       | 23.58               | 0.58      |
| <b>V69 Alcohol and/ or drug related mental and behavioural disorders</b> |                              |                     |           |
| V69_A  | 5,245                        | 10.70               | 0.08      |
| V69_B  | 33,967                       | 69.33               | 0.54      |
| V69_C  | 9,784                        | 19.97               | 0.15      |
| <b>X61 Allergic reactions</b>  |                              |                     |           |
| X61_A  | 18,203                       | 42.26               | 0.29      |
| X61_B  | 24,873                       | 57.74               | 0.39      |
| <b>X62 Poisoning</b>   |                              |                     |           |
| X62_A  | 2,350                        | 3.91                | 0.04      |
| X62_B  | 33,125                       | 55.12               | 0.52      |
| X62_C  | 24,623                       | 40.97               | 0.39      |
| <b>X64 Abuse and neglect</b>   |                              |                     |           |
| X64_A  | 1,107                        | 36.22               | 0.02      |
| X64_B  | 1,949                        | 63.78               | 0.03      |

| AECC class   | No. of stays<br>(NHCDC 2014-15) | AECC within class % | Overall %     |
|--|---------------------------------|---------------------|---------------|
| <b>Y62 Burns</b>                                   |                                 |                     |               |
| Y62_A  | 1,772                           | 4.86                | 0.03          |
| Y62_B  | 4,904                           | 13.45               | 0.08          |
| Y62_C  | 3,172                           | 8.70                | 0.05          |
| Y62_D  | 26,610                          | 72.99               | 0.42          |
| <b>Z611 Falls risk</b>                             |                                 |                     |               |
| Z611_A   | 37,547                          | 100.00              | 0.59          |
| <b>Z612 Pain syndrome</b>                          |                                 |                     |               |
| Z612_A   | 11,917                          | 100.00              | 0.19          |
| <b>Z613 Signs and symptoms, other</b>              |                                 |                     |               |
| Z613_A   | 73,695                          | 100.00              | 1.16          |
| <b>Z63 Forensic examination</b>                    |                                 |                     |               |
| Z63_A  | 42,356                          | 100.00              | 0.67          |
| <b>Z64 Other factors influencing health status</b> |                                 |                     |               |
| Z64_A  | 26,492                          | 14.94               | 0.42          |
| Z64_B  | 150,815                         | 85.06               | 2.38          |
| <b>Grand Total</b>                                 | <b>6,345,092</b>                |                     | <b>100.00</b> |

# Mapping of ED ICD-10-AM short list to ECDGs

This Chapter shows the mapping of IHPA's Emergency department ICD-10-AM (ninth edition) principal diagnosis short list to the proposed ECDGs. Further information on the short list is available from IHPA's website:

<https://www.ihoa.gov.au/what-we-do/classifications/emergency-care/emergency-department-icd-10-am-ninth-edition-principal-diagnosis-short-list>

|  |
|--|
| <b>B63 Dementia/ chronic brain syndrome</b>  |
| F03 Dementia (except in Alzheimer's disease)   |
| F09 Mental, personality and behavioural disorders due to brain damage or physical disease, other |
| G309 Alzheimer's disease or sclerosis  |
| <b>B64 Delirium/ confusion/ acute encephalopathy</b>   |
| F051 Delirium due to dementia  |
| F059 Delirium due to disease or infection  |
| I674 Encephalopathy, hypertensive  |
| R400 Drowsiness, altered loss of consciousness   |
| R402 Coma (except in diabetes)   |
| R410 Disorientation or confusion   |
| R418 Symptoms involving cognition and awareness, other   |
| <b>B69 TIA and precerebral occlusion</b>   |
| G450 Transient vertebro-basilar artery syndrome (insufficiency)(VBI)                             |
| G459 Transient cerebral ischaemic attack (TIA)   |
| <b>B70 Stroke &amp; other cerebrovascular disorders</b>  |
| G819 Hemiplegia  |
| I609 Haemorrhage, subarachnoid (SAH), nontraumatic   |
| I619 Haemorrhage, intracerebral (ICH), nontraumatic  |
| I620 Haemorrhage, subdural (SDH), nontraumatic   |
| I629 Haemorrhage, intracranial, nontraumatic, other  |
| I639 Infarction, cerebral, nontraumatic  |
| I64 Stroke, cerebrovascular accident (CVA)   |
| I669 Occlusion, stenosis of cerebral artery (cerebral embolism)                                  |
| I679 Cerebrovascular disease, other  |
| <b>B72 CNS infection/ inflammation</b>   |
| A809 Poliomyelitis, acute  |

|  |
|--|
| A810 Creutzfeldt-Jakob disease (CJD) or variant CJD                                |
| A830 Encephalitis, Japanese  |
| A834 Encephalitis, Australian (Murray Valley)                                      |
| A879 Meningitis, viral   |
| G009 Meningitis, bacterial   |
| G039 Meningitis (except viral or bacterial)  |
| G049 Encephalitis, encephalomyelitis or myelitis, other                            |
| G062 Abscess or granuloma of brain or spinal cord                                  |
| <b>B81 Disorders of the nervous system, other</b>                                  |
| G129 Spinal muscular ataxia and systemic atrophies (includes motor neuron disease) |
| G20 Parkinson's disease  |
| G249 Dystonia  |
| G259 Abnormal movement disorder, other   |
| G35 Multiple sclerosis   |
| G379 Nervous system demyelinating disorder, other                                  |
| G4010 Epilepsy, focal or partial seizures  |
| G4030 Epilepsy, generalised seizures (includes grand mal and petit mal seizures)   |
| G4090 Epilepsy, other or unidentified seizure                                      |
| G419 Epilepsy with status epilepticus  |
| G439 Migraine  |
| G440 Headache, cluster   |
| G442 Headache, tension-type  |
| G448 Headache syndrome, other  |
| G500 Nerve disorder, trigeminal neuralgia  |
| G510 Bell's palsy and other facial nerve disorder                                  |
| G529 Nerve disorder, cranial (except facial and trigeminal nerve)                  |
| G549 Nerve root and plexus disorder  |
| G560 Carpal tunnel syndrome  |
| G589 Mononeuropathy, other   |
| G610 Guillain-Barre syndrome   |
| G629 Polyneuropathy (except Guillain-Barre)  |
| G64 Peripheral nervous system disorder, other                                      |
| G700 Myasthenia gravis   |
| G729 Myopathy, other   |
| G809 Cerebral palsy  |
| G834 Cauda equina syndrome   |
| G839 Paralysis, other (includes paraplegia, tetraplegia)                           |
| G919 Hydrocephalus, acquired   |
| G932 Hypertension, benign intracranial (except hypertensive encephalopathy)        |
| G939 Encephalopathy and other brain disorder                                       |
| G959 Spinal cord disease (includes cord compression)                               |
| G971 Postprocedural disorder, post spinal and lumbar puncture                      |

|  |
|--|
| G98 Nervous system disorder, other   |
| P90 Convulsions, newborn (except familial epilepsy)                                  |
| R208 Anaesthesia of skin   |
| R252 Cramp or spasm  |
| R268 Abnormal gait or mobility   |
| R2989 Symptoms of musculoskeletal and nervous systems, other                         |
| R470 Dysphasia or aphasia  |
| R478 Symptoms of speech (and voice) disturbance, other (dysarthria)                  |
| R51 Headache, unspecified  |
| R560 Convulsions, febrile  |
| R568 Convulsions, other  |
| <b>C633 Eye disorder, other</b>  |
| B309 Conjunctivitis, viral   |
| H000 Inflammation of eyelid, stye, abscess, furuncle (boil), carbuncle or cellulitis |
| H001 Chalazion   |
| H019 Inflammation of eyelid, dermatitis, blepharitis, other                          |
| H029 Eyelid disorder, other  |
| H049 Inflammation or disorder of lacrimal system of eye (tear duct)                  |
| H050 Inflammation, infection of orbital or periorbital tissue, acute                 |
| H059 Orbital tissue disorder, other  |
| H101 Conjunctivitis, acute atopic (allergic)   |
| H109 Conjunctivitis, other   |
| H110 Pterygium   |
| H113 Conjunctival haemorrhage, nontraumatic  |
| H119 Conjunctiva disorder, other   |
| H160 Corneal ulcer   |
| H169 Keratitis   |
| H189 Corneal disorder (keratopathy), other   |
| H209 Iridocyclitis   |
| H219 Hyphaema and other disorders of iris and ciliary body                           |
| H269 Cataract  |
| H279 Eye lens disorder, other  |
| H335 Retinal detachment  |
| H356 Retinal haemorrhage   |
| H359 Retinal disorders (retinopathy, choroidopathy), other                           |
| H409 Glaucoma  |
| H439 Vitreous body disorder  |
| H449 Eye globe disorder  |
| H46 Optic neuritis   |
| H477 Optic nerve and visual pathway disorders (includes papilloedema), other         |
| H531 Visual disturbance, subjective  |
| H532 Diplopia  |

|   |
|---|
| H539 Visual disturbance, other  |
| H540 Blindness, binocular   |
| H544 Blindness, monocular   |
| H549 Visual loss, other   |
| H571 Pain in eye (ocular pain)  |
| H579 Eye or adnexa disorder, other                                      |
| <b>D66 Ear, nose, mouth and throat disorders, other</b>                 |
| H601 Cellulitis, external ear   |
| H603 Otitis externa, infective  |
| H609 Otitis externa, non-infective                                      |
| H612 Impacted cerumen, external ear                                     |
| H619 Ear disease, external ear, other                                   |
| H659 Otitis media, nonsuppurative                                       |
| H664 Otitis media, suppurative  |
| H669 Otitis media, other  |
| H699 Eustachian tube disorder   |
| H709 Mastoiditis  |
| H729 Perforation of tympanic membrane                                   |
| H749 Ear disease, middle ear and mastoid diseases, other                |
| H810 Meniere's disease  |
| H811 Vertigo, benign paroxysmal   |
| H812 Vestibular neuronitis  |
| H819 Vestibular function disorder                                       |
| H830 Labyrinthitis  |
| H839 Ear disease, inner ear, other                                      |
| H919 Hearing loss (deafness)  |
| H920 Otagia (earache)   |
| H921 Otorrhoea (discharge from ear)                                     |
| H931 Tinnitus   |
| H939 Ear disorders, unspecified as external, middle or inner ear, other |
| K109 Jaw disease (mandible or maxilla)                                  |
| K112 Sialoadenitis  |
| K115 Sialolithiasis (calculus of salivary gland or duct)                |
| K119 Salivary gland disease, other                                      |
| K120 Stomatitis, aphthae, recurrent                                     |
| K121 Stomatitis, other  |
| K122 Abscess or cellulitis of mouth                                     |
| K137 Lesion of oral mucosa, other                                       |
| K149 Tongue disease   |
| R040 Epistaxis  |
| <b>D671 Teeth and supporting structures disorders, other</b>            |
| K007 Teething   |

|   |
|---|
| K029 Dental caries  |
| K044 Periodontitis  |
| K047 Abscess, dental, apical or periapical tissue   |
| K050 Gingivitis, acute  |
| K051 Gingivitis, chronic  |
| K069 Gingiva, periodontal or alveolar ridge disorder, other                               |
| K076 Temporomandibular joint disorder (except dislocation or strain)                      |
| K089 Teeth and supporting structures disorders, other                                     |
| S025 Fracture of tooth  |
| <b>E61 Major respiratory diagnosis</b>  |
| I269 Embolism, pulmonary (PE)   |
| J80 Respiratory distress syndrome, adult  |
| J9699 Respiratory failure, acute or chronic   |
| P2840 Apnoea in newborn   |
| R092 Respiratory arrest   |
| <b>E623 Upper respiratory tract infection (URTI), other</b>                               |
| J00 Nasopharyngitis (common cold), acute  |
| J019 Sinusitis, acute   |
| J029 Pharyngitis, acute   |
| J039 Tonsillitis, acute   |
| J040 Laryngitis, acute  |
| J069 Upper respiratory tract infection (URTI), acute                                      |
| J304 Rhinitis, allergic   |
| J329 Sinusitis, chronic   |
| J348 Sinus disorder, other  |
| J350 Tonsillitis, chronic   |
| J351 Tonsillar hypertrophy  |
| J36 Abscess, tonsillar (includes peritonsillar)   |
| J399 Upper respiratory tract disease, other   |
| R070 Pain in throat   |
| <b>E65 Chronic obstructive airways disease</b>  |
| J42 Bronchitis, chronic   |
| J439 Emphysema  |
| J440 Chronic obstructive pulmonary disease (COPD), with acute lower respiratory infection |
| J441 Chronic obstructive pulmonary disease (COPD), with acute exacerbation                |
| J449 Chronic obstructive pulmonary disease (COPD), other                                  |
| <b>E69 Asthma/ wheeze/ croup/ airway infection</b>  |
| J041 Tracheitis, acute  |
| J050 Croup (acute obstructive laryngitis)   |
| J051 Epiglottitis, acute  |
| J219 Bronchiolitis, acute   |
| J459 Asthma   |

|   |
|---|
| J46 Asthma, severe, acute (status asthmaticus)  |
| R062 Wheezing   |
| <b>E753 Respiratory disorder, other</b>   |
| A169 Respiratory tuberculosis   |
| A188 Tuberculosis (except respiratory)  |
| A379 Pertussis (whooping cough)   |
| A481 Legionellosis (Legionnaires' disease, Pontiac fever)   |
| B953 Pneumococcal disease (Streptococcus pneumoniae)  |
| B972 Middle East Respiratory Syndrome, coronavirus (MERS-CoV) or severe acute respiratory syndrome (SARS) |
| E84 Cystic fibrosis   |
| G4730 Sleep apnoea  |
| J09 Influenza A/H5N1 (avian influenza)  |
| J101 Influenza, virus identified (except influenza A/H5N1 (avian influenza))                              |
| J111 Influenza, virus not identified  |
| J129 Pneumonia, viral   |
| J159 Pneumonia, bacterial   |
| J180 Bronchopneumonia, organism not identified  |
| J181 Pneumonia, lobar, organism not identified  |
| J189 Pneumonia, organism not identified   |
| J209 Bronchitis, acute  |
| J22 Lower respiratory tract infection (LRTI), acute   |
| J40 Bronchitis, not identified as acute or chronic  |
| J47 Bronchiectasis (except bronchiectasis in cystic fibrosis)   |
| J690 Pneumonia, aspiration due to food and vomit  |
| J709 Respiratory conditions due to external agents, other   |
| J849 Respiratory disease, interstitial, other   |
| J90 Pleural effusion  |
| J939 Pneumothorax, spontaneous, nontraumatic  |
| J950 Postprocedural malfunction of tracheostomy   |
| J984 Lung disorder, other   |
| J989 Respiratory disorder, upper or lower tract, other  |
| R042 Haemoptysis  |
| R05 Cough   |
| R060 Dyspnoea (shortness of breath)   |
| R061 Stridor (harsh, high-pitched breathing sound)  |
| R064 Hyperventilation   |
| R068 Breathing abnormalities, other   |
| R091 Pleurisy (except with effusion)  |
| R0989 Symptoms of circulatory and respiratory systems   |
| <b>F60 Acute coronary syndrome</b>  |
| I200 Angina pectoris, unstable  |
| I209 Angina pectoris, stable or unspecified   |



|  |
|--|
| I213 Myocardial infarction, transmural, acute (STEMI)  |
| I214 Myocardial infarction, subendocardial, acute (NSTEMI)   |
| I219 Myocardial infarction, acute, other   |
| I249 Ischaemic heart disease, acute  |
| <b>F62 Heart failure and shock</b>   |
| I500 Congestive cardiac failure (CCF)  |
| I501 Left ventricular failure (LVF)  |
| I509 Heart failure, other  |
| J81 Oedema, lung (pulmonary oedema)  |
| <b>F74 Chest pain</b>  |
| R071 Pain in chest on breathing  |
| R074 Pain in chest, other  |
| <b>F75 Circulatory disorders, other</b>  |
| I00 Rheumatic fever, acute, without heart involvement  |
| I099 Rheumatic heart disease   |
| I10 Hypertension, essential, primary (high blood pressure)   |
| I139 Hypertensive heart or kidney disease  |
| I159 Hypertension, secondary   |
| I259 Ischaemic heart disease, chronic (atherosclerotic)  |
| I289 Pulmonary vessel disease, other   |
| I309 Pericarditis, acute   |
| I313 Pericardial effusion, noninflammatory   |
| I319 Pericardial disease, other  |
| I339 Endocarditis, acute (except valve disorders)  |
| I38 Endocarditis, valve insufficiency, or stenosis   |
| I409 Myocarditis, acute  |
| I429 Cardiomyopathy  |
| I519 Heart disease, other  |
| I710 Aneurysm, dissecting, aorta, site not specified, with or without rupture                        |
| I713 Aneurysm, dissecting, abdominal aorta, rupture  |
| I714 Aneurysm, dissecting, abdominal aorta, without rupture  |
| I719 Aneurysm, dissecting, aorta, site not specified, with or without rupture                        |
| I729 Aneurysm, dissecting, arteries (except aorta and cerebral), with or without rupture             |
| I739 Peripheral vascular disease (except embolism and thrombosis)                                    |
| I749 Embolism or thrombosis of artery, other   |
| I779 Artery disorders, other   |
| I800 Phlebitis or thrombophlebitis of superficial vessels, lower extremities                         |
| I802 Phlebitis or thrombophlebitis of deep vessels, lower extremities (deep venous thrombosis) (DVT) |
| I809 Phlebitis or thrombophlebitis, other  |
| I829 Embolism or thrombosis of vein (except veins of lower extremity)                                |
| I839 Varicose veins of lower extremities   |
| I850 Varices, oesophageal  |

|  |
|--|
| I879 Vein disorder, other  |
| I951 Hypotension, postural   |
| I959 Hypotension, other  |
| I99 Circulatory system disorder, other                                       |
| Q249 Malformation, deformation of heart, congenital                          |
| R002 Palpitations  |
| R02 Gangrene   |
| R55 Syncope or collapse (except heat syncope)                                |
| <b>F76 Arrhythmia and cardiac arrest</b>                                     |
| I442 Atrioventricular block, complete  |
| I459 Conduction disorder (except complete atrioventricular block)            |
| I469 Cardiac arrest  |
| I471 Tachycardia, supraventricular   |
| I472 Tachycardia, ventricular  |
| I479 Tachycardia, paroxysmal other   |
| I489 Atrial fibrillation or atrial flutter                                   |
| I490 Ventricular fibrillation or flutter                                     |
| I495 Sick sinus syndrome   |
| I499 Cardiac arrhythmia, other   |
| R000 Tachycardia   |
| R001 Bradycardia   |
| <b>G61 Gastrointestinal haemorrhage</b>                                      |
| K226 Mallory-Weiss tear (gastro-oesophageal laceration-haemorrhage syndrome) |
| K920 Haematemesis  |
| K921 Melaena   |
| K922 Haemorrhage, gastrointestinal (includes per rectal bleeding)            |
| <b>G65 Gastrointestinal obstruction</b>                                      |
| K561 Intussusception of intestine (except appendix)                          |
| K562 Volvulus of intestine   |
| K566 Obstruction of intestine (bowel, ileus)                                 |
| <b>G661 Gastrointestinal peritonitis/ perforation</b>                        |
| K274 Peptic ulcer with haemorrhage or perforation, acute or chronic          |
| K279 Peptic ulcer without haemorrhage or perforation, acute or chronic       |
| K358 Appendicitis, acute   |
| K37 Appendicitis, nonacute or not specified                                  |
| K5780 Diverticulosis, with perforation or abscess                            |
| K5782 Diverticulitis, with perforation or abscess                            |
| K5792 Diverticulitis, without perforation or abscess                         |
| K659 Peritonitis   |
| K859 Pancreatitis, acute   |
| R100 Pain in abdomen, acute (acute abdomen)                                  |
| <b>G662 Abdominal pain</b>   |

|   |
|---|
| I880 Lymphadenitis, mesenteric  |
| K291 Gastritis, acute   |
| K2920 Gastritis, alcoholic  |
| K2970 Gastritis, other  |
| K30 Dyspepsia, functional   |
| K389 Appendix disease, other  |
| K509 Crohn's disease  |
| R101 Pain in abdomen, upper   |
| R103 Pain in abdomen, lower (includes groin)  |
| R104 Pain in abdomen, other (includes colic)  |
| <b>G67 Oesophagitis and gastroenteritis</b>   |
| A009 Cholera  |
| A039 Shigellosis  |
| A045 Campylobacteriosis (Campylobacter enteritis)   |
| A051 Botulism   |
| A059 Bacterial food-borne infection, intoxication   |
| A071 Giardiasis (lambliasis)  |
| A072 Cryptosporidiosis  |
| A081 Noroviral enteritis  |
| A084 Intestinal infection, viral, other   |
| A085 Intestinal infection, non viral  |
| A099 Colitis, gastroenteritis, diarrhoea, not known if bacterial, protozoal or viral        |
| B839 Helminthiasis (worm) infection   |
| <b>G702 Digestive system disorders, other</b>   |
| K20 Oesophagitis, with or without gastro-oesophageal reflux disease (GORD)                  |
| K219 Gastro-oesophageal reflux disease (GORD), without oesophagitis                         |
| K222 Obstruction (stricture) of oesophagus  |
| K224 Dyskinesia of oesophagus   |
| K229 Oesophageal disease, other   |
| K319 Stomach and duodenum disease, other  |
| K4090 Hernia, inguinal  |
| K4091 Unilateral or unspecified inguinal hernia, without obstruction or gangrene, recurrent |
| K419 Hernia, femoral  |
| K429 Hernia, umbilical  |
| K439 Hernia, ventral (incisional)   |
| K449 Hernia, diaphragmatic  |
| K469 Hernia, abdominal, other   |
| K519 Colitis, ulcerative  |
| K529 Colitis, gastroenteritis, noninfectious  |
| K559 Vascular disorder of intestine   |
| K5790 Diverticulosis, without perforation or abscess  |
| K589 Irritable bowel syndrome (IBS)   |

|  |
|--|
| K590 Constipation  |
| K602 Fissure, anal   |
| K610 Abscess or cellulitis, anal or anorectal                    |
| K623 Prolapse, rectum  |
| K625 Haemorrhage, anus or rectum (except per-rectal bleeding)    |
| K629 Anal and rectal disease, other                              |
| K631 Perforation of intestine, nontraumatic                      |
| K639 Intestinal disease, other                                   |
| K649 Haemorrhoids  |
| K914 Colostomy or enterostomy malfunction                        |
| K919 Postprocedural disorder of digestive system                 |
| K929 Digestive system disease, other                             |
| Q400 Pyloric stenosis, hypertrophic, infantile (congenital)      |
| R11 Nausea and vomiting (except in pregnancy or postprocedural)  |
| R13 Dysphagia  |
| R190 Lump, mass or swelling in intra-abdominal or pelvic region  |
| R198 Symptoms of digestive system or abdomen, other              |
| <b>H63 Disorders of liver</b>                                    |
| B199 Hepatitis, viral (unspecified as to A, B, C, D or E)        |
| K709 Alcoholic liver disease                                     |
| K720 Hepatic failure, acute                                      |
| K729 Hepatic failure, other                                      |
| K759 Hepatic disease, inflammatory (except viral hepatitis)      |
| K769 Hepatic disease, other                                      |
| P599 Jaundice in newborn   |
| R17 Jaundice (except in newborn)                                 |
| <b>H64 Disorders of the biliary tract</b>                        |
| K8010 Cholelithiasis with cholecystitis                          |
| K8020 Cholelithiasis without cholecystitis                       |
| K8050 Choledocholithiasis (biliary colic)                        |
| K8080 Cholelithiasis, other                                      |
| K810 Cholecystitis, acute, without calculus                      |
| K819 Cholecystitis, other  |
| K829 Gallbladder disease, other                                  |
| K830 Cholangitis, without calculus                               |
| K839 Biliary tract disease, other                                |
| K861 Pancreatitis, chronic                                       |
| <b>I01 Major injury, incl. multi-trauma</b>                      |
| S019 Wound, open of other parts of head                          |
| S020 Fracture of skull vault                                     |
| S021 Fracture of skull base                                      |
| S029 Fracture of skull and facial bones, other or multiple parts |

|   |
|---|
| S064 Haemorrhage, extradural (epidural)(EDH), traumatic   |
| S065 Haemorrhage, subdural (SDH), traumatic   |
| S066 Haemorrhage, subarachnoid (SAH), traumatic   |
| S069 Injury, internal, intracranial, other  |
| S079 Crushing injury of head  |
| S089 Amputation, traumatic of ear or other parts of head  |
| S099 Injury, unspecified or suspected of head   |
| S129 Fracture of vertebra, cervical or other parts of neck  |
| S132 Dislocation of vertebra, cervical, or other parts of neck  |
| S1410 Spinal cord injury, traumatic, cervical cord  |
| S146 Nerve injury in neck, brachial plexus  |
| S18 Amputation, traumatic at neck (decapitation)  |
| S2200 Fracture of vertebra, thoracic, or other parts of bony thorax                                   |
| S2410 Spinal cord injury, traumatic, thoracic cord  |
| S279 Injury, internal of intrathoracic organ, other   |
| S281 Amputation, traumatic of part of thorax (chest)  |
| S3200 Fracture of vertebra, lumbar  |
| S3282 Fracture of vertebra, lumbosacral   |
| S341 Spinal cord injury, traumatic, lumbar cord, conus medullaris or cauda equina                     |
| S348 Nerve injury at abdomen, lower back or pelvis level  |
| S359 Vessel injury of abdomen   |
| S3600 Injury, internal of spleen  |
| S3610 Injury, internal of liver   |
| S369 Injury, internal of other intra-abdominal organ  |
| S3700 Injury, internal of kidney  |
| S383 Amputation, traumatic of external genital organs or other parts of abdomen, lower back or pelvis |
| S489 Amputation, traumatic at shoulder level or upper arm   |
| S589 Amputation, traumatic at elbow level or forearm  |
| S789 Amputation, traumatic at hip level or thigh  |
| S889 Amputation, traumatic at knee level or lower leg   |
| T07 Injury, multiple, in significant multi-trauma   |
| T093 Spinal cord injury, traumatic, level unspecified   |
| <b>102 Fractures of neck of femur</b>   |
| S3283 Fracture of pelvic ring and acetabulum, single or multiple fractures                            |
| S7200 Fracture of femur, neck or head (proximal)  |
| S7210 Fracture of femur, trochanter   |
| S723 Fracture of femur, shaft   |
| S7240 Fracture of femur, lower end (distal)   |
| S729 Fracture of femur, other or multiple parts   |
| <b>103 Fractures of shoulder and lower leg, dislocations, sprains and strains</b>                     |
| S134 Sprain or strain of cervical spine (whiplash)  |
| S136 Sprain, strain, rupture or tear of ligaments, muscles or tendons of neck (except cervical spine) |

|   |
|---|
| S232 Dislocation of thoracic vertebra and other parts of thorax (costochondral)                         |
| S233 Sprain or strain of thoracic spine   |
| S235 Sprain, strain, rupture or tear of ligaments, muscles or tendons of thorax (except thoracic spine) |
| S333 Dislocation of lumbar vertebra, sacrum and coccyx (lumbosacral or sacroiliac)                      |
| S4200 Fracture of clavicle (collar bone)  |
| S4210 Fracture of scapula   |
| S4220 Fracture of humerus, upper end (proximal)   |
| S423 Fracture of humerus, shaft   |
| S4240 Fracture of humerus, lower end (distal)   |
| S429 Fracture of upper arm and shoulder, other or multiple parts  |
| S4300 Dislocation of shoulder (glenohumeral)  |
| S431 Dislocation of acromioclavicular joint   |
| S437 Sprain or rupture of ligaments of shoulder girdle  |
| S5310 Dislocation of elbow  |
| S5340 Sprain or rupture of ligaments of elbow   |
| S7300 Dislocation of hip (acetabulum and proximal femur)  |
| S7310 Sprain or rupture of ligaments of hip   |
| S749 Nerve injury in hip or thigh   |
| S759 Vessel injury of hip or thigh  |
| S767 Strain or tear of muscle and tendon of hip or thigh  |
| S772 Crushing injury of hip (acetabulum and proximal femur) and thigh                                   |
| S799 Injury, unspecified or suspected of hip or thigh   |
| S820 Fracture of patella (knee cap)   |
| S8218 Fracture of tibia, upper end, with or without fibula involvement                                  |
| S8228 Fracture of tibia, shaft, with or without fibula involvement                                      |
| S8238 Fracture of tibia, lower end (except medial malleolus)  |
| S8240 Fracture of fibula, alone   |
| S825 Fracture of malleolus, medial (tibia involving ankle)  |
| S826 Fracture of malleolus, lateral (fibula involving malleolus)  |
| S8281 Fracture of malleoli, bimalleolar ankle fracture  |
| S8282 Fracture of malleoli, trimalleolar ankle fracture   |
| S829 Fracture of lower leg, other or multiple parts (except bimalleolar, trimalleolar fractures)        |
| S8310 Dislocation of knee   |
| S836 Sprain or rupture of ligaments of knee   |
| S859 Vessel injury of knee or lower leg   |
| <b>I04 Injuries, fractures (forearm, wrist, ankle, foot), and other injuries</b>                        |
| S449 Nerve injury in shoulder or upper arm  |
| S459 Vessel injury of shoulder and upper arm  |
| S469 Strain or tear of muscle and tendon of shoulder or upper arm                                       |
| S47 Crushing injury of shoulder and upper arm   |
| S499 Injury, unspecified or suspected of shoulder or upper arm  |
| S5220 Fracture of ulna, proximal, shaft or distal end   |

|  |
|--|
| S5230 Fracture of radius, proximal, shaft or distal end                                    |
| S529 Fracture of forearm, other or multiple parts  |
| S549 Nerve injury in forearm   |
| S559 Vessel injury of forearm  |
| S568 Strain or tear of muscle or tendon of elbow or forearm                                |
| S579 Crushing injury of elbow and forearm  |
| S599 Injury, unspecified or suspected of elbow or forearm                                  |
| S6210 Fracture of carpal bone  |
| S6230 Fracture of metacarpal bone(s)   |
| S6250 Fracture of thumb  |
| S6260 Fracture of finger (except thumb)  |
| S628 Fracture of wrist and hand (finger), other or multiple parts                          |
| S6300 Dislocation of wrist (carpal or carpometacarpal joint)                               |
| S6310 Dislocation of finger(s) (metacarpophalangeal or interphalangeal joint)              |
| S6358 Sprain or rupture of ligaments of wrist (carpal)                                     |
| S6368 Sprain or rupture of ligaments of finger(s) (metacarpophalangeal or interphalangeal) |
| S637 Sprain or rupture of ligaments of hand  |
| S649 Nerve injury in wrist or hand (finger)  |
| S659 Vessel injury of wrist or hand (finger)   |
| S669 Strain or tear of muscle and tendon, wrist or hand (finger)                           |
| S678 Crushing injury of wrist and hand (finger)  |
| S699 Injury, unspecified or suspected of wrist or hand                                     |
| S849 Nerve injury in knee or lower leg   |
| S869 Strain or tear of muscle and tendon of knee or lower leg                              |
| S878 Crushing injury of knee and lower leg   |
| S899 Injury, unspecified or suspected of knee or lower leg                                 |
| S920 Fracture of foot, calcaneus (heel bone)   |
| S9220 Fracture of foot, tarsal bone  |
| S923 Fracture of foot, metatarsal bone   |
| S924 Fracture of great toe   |
| S925 Fracture of toe (except great toe)  |
| S929 Fracture of foot, other or multiple parts   |
| S930 Dislocation of ankle (tarsal or tarsometatarsal joint)                                |
| S9310 Dislocation of toe(s) (metatarsophalangeal or interphalangeal joint)                 |
| S9340 Sprain or rupture of ligaments of ankle  |
| S935 Sprain or rupture of ligaments of toe(s)  |
| S936 Sprain or rupture of ligaments of foot  |
| S949 Nerve injury in ankle or foot (toe)   |
| S959 Vessel injury of ankle or foot  |
| S969 Strain or tear of muscle and tendon of ankle or foot (toe)                            |
| S978 Crushing injury of ankle and foot (toes)  |
| S999 Injury, unspecified or suspected of ankle or foot                                     |

|  |
|--|
| T0290 Fracture of multiple anatomical regions, in significant multi-trauma                                       |
| <b>I05 Injuries, other</b>   |
| S023 Fracture of orbital floor   |
| S024 Fracture of malar or maxillary bones  |
| S0260 Fracture of mandible   |
| S030 Dislocation of jaw (temporomandibular)  |
| S049 Nerve injury, cranial nerve (CNI-CN XII)  |
| S092 Injury, internal of ear drum, traumatic rupture   |
| S119 Wound, open of neck   |
| S159 Vessel injury of neck   |
| S179 Crushing injury of neck   |
| S199 Injury, unspecified or suspected of neck  |
| S219 Wound, open of thorax (chest)   |
| S222 Fracture of sternum   |
| S2232 Fracture of rib, single  |
| S2240 Fracture of ribs, multiple   |
| S246 Nerve injury in thorax (chest)  |
| S259 Vessel injury of thorax (chest)   |
| S270 Pneumothorax, traumatic   |
| S271 Haemothorax, traumatic (haemopneumothorax)  |
| S280 Crushing injury of thorax (chest)   |
| S299 Injury, unspecified or suspected of thorax (chest)  |
| S310 Wound, open of lower back or pelvis   |
| S311 Wound, open of abdomen  |
| S312 Wound, open of penis  |
| S313 Wound, open of scrotum or testes  |
| S314 Wound, open of vagina or vulva  |
| S337 Sprain, strain, rupture or tear of ligaments muscles or tendons of lumbar spine (lumbosacral or sacroiliac) |
| S381 Crushing injury of abdomen, lower back and pelvis   |
| S399 Injury, unspecified or suspected of abdomen, lower back or pelvis   |
| S410 Wound, open of shoulder   |
| S411 Wound, open of upper arm  |
| S510 Wound, open, of elbow   |
| S519 Wound, open of forearm  |
| S681 Amputation, traumatic of finger(s)  |
| S689 Amputation, traumatic at wrist level or hand  |
| S710 Wound, open of hip  |
| S711 Wound, open of thigh  |
| S810 Wound, open of knee   |
| S819 Wound, open of lower leg  |
| S981 Amputation, traumatic of toe(s)   |
| S984 Amputation, traumatic at ankle level or foot  |



|   |
|---|
| T019 Wound, open of multiple anatomical regions, widespread   |
| T149 Injury, unspecified or suspected of other region   |
| T357 Frostbite  |
| T670 Heatstroke or sunstroke (hyperthermia)   |
| T671 Heat syncope   |
| T68 Hypothermia   |
| T71 Asphyxiation  |
| T751 Drowning or near drowning  |
| T754 Electrocutation  |
| T789 Adverse effect from other external cause, radiation exposure, or decompression illness                   |
| T793 Complication secondary to trauma, wound infection  |
| T799 Complication secondary to trauma, other  |
| <b>I06 Minor injury, incl. minor head</b>   |
| F072 Postconcussional syndrome  |
| R413 Amnesia, post traumatic  |
| S0000 Superficial injury of scalp   |
| S0020 Superficial injury of eyelid or periorcular area  |
| S0030 Superficial injury of nose  |
| S0040 Superficial injury of ear (auricle and auditory canal)  |
| S0050 Superficial injury of lip or oral cavity  |
| S0090 Superficial injury of other parts of head (cheek, chin, face, forehead, temple)                         |
| S010 Wound, open of scalp   |
| S011 Wound, open of eyelid or periorcular area  |
| S0120 Wound, open of nose   |
| S0130 Wound, open of external ear or auditory structures  |
| S0141 Wound, open of cheek  |
| S0143 Wound, open of mandibular region  |
| S0150 Wound, open of mouth or tongue  |
| S0151 Wound, open of lip  |
| S022 Fracture of nasal bones  |
| S033 Dislocation of other parts of head (includes tooth)  |
| S035 Sprain, strain, rupture or tear of ligaments, muscles or tendons of jaw or other parts of head           |
| S050 Injury, internal of conjunctiva or cornea  |
| S059 Injury, internal, other parts of eye or orbital tissue   |
| S0600 Concussion, cerebral, without loss of consciousness   |
| S0601 Concussive injury with loss of consciousness of unspecified duration                                    |
| S0602 Concussive injury with loss of consciousness of brief duration, less than 30 minutes                    |
| S0603 Concussive injury with loss of consciousness of moderate duration, 30 minutes to 24 hours               |
| S0605 Concussive injury with loss of consciousness of prolonged duration, >24 hours                           |
| S1090 Superficial injury of neck  |
| S2080 Superficial injury of thorax (chest)  |
| S3090 Superficial injury, abdomen, lower back and pelvis (anus, buttocks, external genitalia, flank or groin) |

|   |
|---|
| S409 Superficial injury of shoulder or upper arm                          |
| S509 Superficial injury of elbow or forearm                               |
| S609 Superficial injury of wrist or hand (finger)                         |
| S610 Wound, open of finger, with or without nail involvement              |
| S619 Wound, open of wrist or hand (except finger)                         |
| S709 Superficial injury of hip or thigh                                   |
| S809 Superficial injury of knee or lower leg                              |
| S909 Superficial injury of ankle or foot (toe)                            |
| S910 Wound, open of ankle   |
| S911 Wound, open of toe(s)  |
| S913 Wound, open of foot (except toe)                                     |
| T009 Superficial injuries, across multiple anatomical regions, widespread |
| T150 Foreign body in cornea   |
| T151 Foreign body in conjunctival sac                                     |
| T159 Foreign body in external eye, other                                  |
| T16 Foreign body in ear   |
| T170 Foreign body in nasal sinus  |
| T171 Foreign body in nostril  |
| T172 Foreign body in pharynx  |
| T179 Foreign body in respiratory tract, other                             |
| T181 Foreign body in oesophagus   |
| T182 Foreign body in stomach  |
| T189 Foreign body in alimentary tract, other                              |
| T192 Foreign body in vulva or vagina                                      |
| T199 Foreign body in genitourinary tract, other                           |
| <b>I71 Musculotendinous disorders, other</b>                              |
| M0099 Arthritis, infective (pyogenic )                                    |
| M0699 Arthritis, rheumatoid   |
| M1099 Gout  |
| M1399 Arthritis, other (except infective or rheumatoid)                   |
| M1999 Osteoarthritis (arthrosis, degenerative joint disease)              |
| M200 Malformation, deformation of finger (mallet finger), acquired        |
| M220 Dislocation or subluxation of patella, recurrent, nontraumatic       |
| M2399 Derangement of ligament or meniscus of knee                         |
| M2485 Derangement of joint of pelvic region and thigh                     |
| M2509 Haemarthrosis of joint  |
| M2549 Effusion of joint   |
| M2551 Pain in joint, shoulder region                                      |
| M2552 Pain in joint, upper arm  |
| M2553 Pain in joint, forearm  |
| M2554 Pain in joint, hand   |
| M2555 Pain in joint, pelvis and thigh                                     |

|   |
|---|
| M2556 Pain in joint, lower leg  |
| M2557 Pain in joint, ankle and foot   |
| M2559 Pain in joint, other sites  |
| M2599 Joint disorder, other   |
| M359 Systemic (diffuse) connective tissue and autoimmune disorder                           |
| M436 Torticollis  |
| M4899 Spondylopathy   |
| M519 Intervertebral disc disorder, degenerative, with or without radiculopathy or sciatica  |
| M533 Sacrococcygeal disorders   |
| M5399 Spinal column disorders (dorsopathies)  |
| M5419 Radiculopathy (except in intervertebral disc disorder)                                |
| M542 Pain in neck region, cervicalgia (except in intervertebral disc disorder)              |
| M543 Sciatica (except in radiculopathy or intervertebral disc disorder)                     |
| M545 Pain in back, lumbar region (except in intervertebral disc disorder)                   |
| M546 Pain in back, thoracic region (except in intervertebral disc disorder)                 |
| M5499 Pain in back, generalised (dorsalgia)   |
| M6299 Muscle disorder (except myalgia, myopathy or muscular dystrophy)                      |
| M6599 Tenosynovitis or synovitis  |
| M6659 Tendon rupture, spontaneous, nontraumatic   |
| M6749 Ganglion  |
| M702 Bursitis, olecranon  |
| M704 Bursitis, prepatellar  |
| M712 Cyst, Bakers (synovial cyst of popliteal space)  |
| M7199 Bursitis, other   |
| M750 Capsulitis, adhesive (frozen shoulder)   |
| M751 Rotator cuff syndrome (spontaneous supraspinatus tear or rupture)                      |
| M759 Lesion of shoulder, other  |
| M766 Tendinitis, Achilles   |
| M779 Enthesopathy, other  |
| M7919 Myalgia   |
| M7929 Neuralgia or neuritis (except cranial nerve pain)                                     |
| M7969 Pain in limb, any site (except joint)   |
| M7999 Soft tissue disorder of musculoskeletal system  |
| M8449 Fracture, pathological (includes osteitis, periostitis)                               |
| M8699 Osteomyelitis (includes osteitis, periostitis, infective)                             |
| M8999 Bone disorder, other  |
| M940 Costochondritis (Tietze syndrome)  |
| M9499 Cartilage disorder, other   |
| M959 Malformation, deformation of musculoskeletal and connective tissue, other (acquired)   |
| <b>185 Complications of surgical and medical care</b>                                       |
| T809 Complication, postprocedural, following infusion, transfusion or therapeutic injection |
| T810 Complication, postprocedural, haemorrhage or haematoma                                 |

|   |
|---|
| T814 Complication, postprocedural, wound infection (except infection from devices)                              |
| T819 Complication, postprocedural, other  |
| T829 Complication, postprocedural, of cardiac or vascular prosthetic device, implant, or graft                  |
| T830 Complication, postprocedural, of urinary indwelling catheter, mechanical                                   |
| T839 Complication, postprocedural, of prosthetic device or implant or graft, genitourinary                      |
| T849 Complication, postprocedural, of internal prosthetic device or implant or graft, orthopaedic               |
| T855 Complication, postprocedural, of prosthetic device or implant or graft, gastrointestinal, mechanical       |
| T859 Complication, postprocedural, of prosthetic device or implant or graft (internal), other prosthetic device |
| T887 Complication, adverse effect from drug or medicament in therapeutic care (anaphylaxis)                     |
| T889 Complication following other medical care  |
| <b>J64 Cellulitis/ skin infection</b>   |
| A46 Erysipelas  |
| L010 Impetigo   |
| L020 Abscess, furuncle or carbuncle of face (boil)  |
| L021 Abscess, furuncle or carbuncle of neck (boil)  |
| L022 Abscess, furuncle or carbuncle of trunk (boil)   |
| L023 Abscess, furuncle or carbuncle of buttock (boil)   |
| L0240 Abscess, furuncle or carbuncle of upper or lower limb (boil)  |
| L029 Abscess, furuncle or carbuncle of other site (boil)  |
| L0301 Cellulitis of finger  |
| L0302 Cellulitis of toe   |
| L0312 Cellulitis of upper limb  |
| L0313 Cellulitis of lower limb  |
| L0314 Cellulitis of foot  |
| L032 Cellulitis of face   |
| L033 Cellulitis of trunk  |
| L039 Cellulitis of other site   |
| L050 Cyst, pilonidal with abscess   |
| L089 Infection of skin and subcutaneous tissue, local (except viral)  |
| N61 Breast inflammatory disorder (mastitis), not associated with childbirth                                     |
| <b>J67 Skin disorders, other</b>  |
| B353 Tinea pedis  |
| B359 Dermatophytosis, other   |
| B370 Candidal stomatitis (oral thrush)  |
| B373 Candidiasis of vulva or vagina   |
| B379 Candidiasis, other   |
| B86 Scabies   |
| L059 Cyst, pilonidal without abscess  |
| L209 Dermatitis, atopic   |
| L219 Dermatitis, seborrhoeic  |
| L22 Dermatitis, due to nappy (nappy rash)   |
| L239 Dermatitis, allergic contact (except eyelid and external ear)  |

|   |
|---|
| L270 Dermatitis or rash due to drugs or medicaments   |
| L299 Pruritus   |
| L309 Dermatitis, other  |
| L409 Psoriasis  |
| L449 Papulosquamous disorders (pityriasis rosea)  |
| L500 Urticaria, allergic  |
| L501 Urticaria, idiopathic  |
| L509 Urticaria, other   |
| L519 Erythema, multiforme   |
| L539 Erythema, other (except burn or sunburn)   |
| L600 Ingrowing (ingrown) nail   |
| L609 Nail disorder, other   |
| L721 Cyst, sebaceous, trichilemmal or pilar   |
| L739 Folliculitis   |
| L740 Heat rash (miliaria rubra)   |
| L8990 Ulcer (injury), pressure (decubitus ulcer, bed sore)  |
| L979 Ulcer of lower limb (except pressure ulcer)  |
| L984 Ulcer of skin (except lower limb)  |
| L989 Skin and subcutaneous tissue disorder, other   |
| N63 Breast lump, morphology unknown   |
| N644 Breast pain (mastodynia), not associated with childbirth                                       |
| N649 Breast disorder, other   |
| R21 Rash  |
| R229 Lump, mass in skin and subcutaneous tissue, other  |
| R238 Symptoms involving skin and subcutaneous tissue, other   |
| <b>K60 Diabetes</b>   |
| E1011 Diabetes mellitus type 1, with ketoacidosis, with or without coma                             |
| E1065 Diabetes mellitus type 1 with poor glycaemic control, unstable                                |
| E108 Diabetes mellitus type 1, with complication (except poor glycaemic control)                    |
| E109 Diabetes mellitus type 1, without complication   |
| E1111 Diabetes mellitus type 2, with ketoacidosis, with or without coma                             |
| E1165 Diabetes mellitus type 2 with poor glycaemic control, unstable                                |
| E118 Diabetes mellitus type 2, with other complication (except poor glycaemic control)              |
| E119 Diabetes mellitus type 2, without complication   |
| E1411 Diabetes mellitus, type not specified, with ketoacidosis, with or without coma                |
| E1465 Diabetes mellitus, type not specified with poor glycaemic control, unstable                   |
| E148 Diabetes mellitus, type not specified, with other complication (except poor glycaemic control) |
| E149 Unspecified diabetes mellitus without complication   |
| <b>K62 Miscellaneous metabolic disorders</b>  |
| E039 Hypothyroidism   |
| E059 Thyrotoxicosis (hyperthyroidism)   |
| E079 Thyroid disorders, other   |

|  |
|--|
| E162 Hypoglycaemia   |
| E272 Addisonian crisis   |
| E279 Adrenocortical insufficiency and adrenal gland disorders, other     |
| E299 Testicular dysfunction  |
| E349 Endocrine disorders, other  |
| E46 Malnutrition from protein-energy deficiency                          |
| E639 Vitamin and nutrient element deficiencies                           |
| E835 Hypercalcaemia  |
| E839 Metabolism disorders, mineral metabolism, other                     |
| E86 Dehydration and other volume depletion                               |
| E870 Hyperosmolality (except with diabetes mellitus) and hypernatraemia  |
| E871 Hypo-osmolality and hyponatraemia                                   |
| E875 Hyperkalaemia   |
| E876 Hypokalaemia  |
| E877 Fluid overload (except with oedema)                                 |
| E878 Electrolyte or fluid imbalance, other                               |
| E889 Metabolic disorders, obesity and hyperalimantation disorders, other |
| R628 Delayed development or milestones                                   |
| R630 Anorexia (except anorexia nervosa)                                  |
| R634 Abnormal weight loss  |
| <b>L60 Renal failure</b>   |
| N179 Kidney failure, acute   |
| N189 Kidney failure, chronic kidney disease stage 5                      |
| N19 Kidney failure, other  |
| <b>L672 Kidney and urinary tract disorders, other</b>                    |
| N049 Nephrosis (nephrotic syndrome)                                      |
| N059 Nephritis, glomeruli (nephritic syndrome, glomerulonephritis)       |
| N12 Nephritis, tubulo-interstitial (pyelonephritis)                      |
| N133 Hydronephrosis  |
| N139 Uropathy, reflux, obstructive (urinary tract obstruction)           |
| N200 Calculus, kidney  |
| N201 Calculus, ureter  |
| N209 Calculus, urinary, other  |
| N23 Colic, renal, other  |
| N289 Kidney or ureter disease, other (nephropathy or ureteropathy)       |
| N309 Cystitis  |
| N342 Urethritis  |
| N390 Urinary tract infection (UTI)                                       |
| N399 Urinary system disorder, other                                      |
| N999 Postprocedural disorder of genitourinary system                     |
| R300 Dysuria   |
| R31 Haematuria   |

|   |
|---|
| R33 Urinary retention   |
| R398 Symptoms of urinary system, other  |
| <b>M64 Male reproductive system disorders</b>                                   |
| N40 Hyperplasia of prostate   |
| N419 Prostatitis (inflammatory disease of prostate)                             |
| N433 Hydrocele  |
| N44 Torsion of testis   |
| N459 Orchitis, epididymitis, or epididymo-orchitis                              |
| N47 Phimosis and paraphimosis, redundant prepuce                                |
| N481 Balanitis (balanoposthitis)  |
| N489 Penis disorder, other  |
| N509 Genital organ disorder, male, other  |
| <b>N62 Menstrual and other female reproductive system disorders</b>             |
| E282 Polycystic ovarian syndrome  |
| E289 Ovarian dysfunction, other   |
| N719 Inflammatory disease of uterus (endometritis)                              |
| N739 Pelvic inflammatory disease, female  |
| N750 Cyst, Bartholin's gland  |
| N751 Abscess, Bartholin's gland   |
| N760 Vaginitis (vulvovaginitis), acute  |
| N764 Abscess of vulva   |
| N768 Vaginal or vulval inflammation, other                                      |
| N809 Endometriosis  |
| N819 Prolapse of genital organs, female   |
| N832 Cyst, ovary  |
| N899 Vaginal noninflammatory disorder   |
| N920 Menorrhagia  |
| N926 Menstruation, irregular  |
| N930 Bleeding, postcoital and contact   |
| N939 Bleeding, vaginal or uterine, abnormal (except postmenopausal bleeding)    |
| N940 Ovulation pain (Mittelschmerz)   |
| N946 Dysmenorrhoea  |
| N949 Genital organ disorder, female, noninflammatory, other                     |
| N959 Menopausal, perimenopausal and postmenopausal disorder (includes bleeding) |
| <b>O61 Postpartum and post abortion</b>   |
| O021 Abortion, missed   |
| O034 Abortion, spontaneous, incomplete, without complication                    |
| O039 Abortion, spontaneous, complete or unspecified, without complication       |
| O089 Abortion with other complication, ectopic or molar pregnancy               |
| O721 Haemorrhage, postpartum, immediate   |
| O722 Haemorrhage, postpartum, delayed or secondary                              |
| O85 Sepsis, puerperal   |

|   |
|---|
| O860 Infection of obstetric surgical wound                                  |
| O900 Disruption (dehiscence) of caesarean section wound                     |
| O901 Disruption (dehiscence) of perineal obstetric wound                    |
| O909 Complication of the puerperium (up to 42 days following birth), other  |
| O9120 Mastitis, nonpurulent   |
| <b>O66 Antenatal and other obstetric presentation</b>                       |
| O009 Ectopic pregnancy, ruptured ectopic pregnancy                          |
| O149 Pre-eclampsia or eclampsia   |
| O16 Hypertension, maternal (except pre-eclampsia or eclampsia)              |
| O200 Abortion, threatened   |
| O210 Hyperemesis gravidarum   |
| O219 Vomiting during pregnancy, other                                       |
| O269 Obstetric (maternal) condition, other                                  |
| O369 Maternal care for fetal problem  |
| O429 Premature rupture of membranes (PROM)                                  |
| O469 Haemorrhage, antepartum  |
| O479 False labour   |
| O600 Preterm labour without delivery  |
| O601 Preterm labour with delivery   |
| O759 Delivery or labour with complication                                   |
| O80 Delivery, single spontaneous, fullterm                                  |
| O864 Pyrexia of unknown origin following delivery                           |
| O998 Obstetric condition, other (includes obstetric death)                  |
| <b>P68 Perinatal disorders</b>  |
| P929 Feeding problem in newborn   |
| P969 Perinatal disorder in the fetus or newborn, other                      |
| <b>Q60 Reticuloendothelial and immunity disorders</b>                       |
| D70 Agranulocytosis (includes neutropenia)                                  |
| D759 Blood and blood forming organ diseases, other                          |
| D899 Immune mechanism disorder (except systemic autoimmune and HIV disease) |
| I899 Lymphatic vessel or lymph node disorder, noninfective                  |
| L049 Lymphadenitis, acute (except mesenteric lymphadenitis)                 |
| R599 Lymphadenopathy  |
| <b>Q61 Red blood cell disorders</b>   |
| D509 Anaemia, iron deficient  |
| D578 Anaemia, sickle-cell, with or without crisis                           |
| D599 Anaemia, acquired haemolytic   |
| D619 Anaemia, aplastic  |
| D649 Anaemia, nutritional, hereditary haemolytic, other                     |
| <b>Q62 Haemostasis</b>  |
| D66 Haemophilia (hereditary factor VIII, IX and XI)                         |
| D689 Coagulation factor defect, other                                       |



|   |
|---|
| D690 Purpura, allergic  |
| D693 Thrombocytopenic purpura, idiopathic   |
| D696 Thrombocytopenia, other  |
| <b>R62 Neoplastic disorders</b>   |
| C189 Neoplasm, malignant, primary site of colon   |
| C259 Neoplasm, malignant, primary site of pancreas  |
| C269 Neoplasm, malignant, primary site of digestive system or hepatobiliary system, other                 |
| C349 Neoplasm, malignant, primary site of bronchus or lung (includes mesothelioma)                        |
| C399 Neoplasm, malignant, primary site of respiratory system or intrathoracic organs, other               |
| C439 Neoplasm, malignant, melanoma of skin  |
| C449 Neoplasm, malignant, primary site of skin (except melanoma)  |
| C509 Neoplasm, malignant, primary site of breast  |
| C579 Neoplasm, malignant, primary site of female genital organ  |
| C61 Neoplasm, malignant, primary site of prostate   |
| C639 Neoplasm, malignant, primary site of other male genital organ  |
| C719 Neoplasm, malignant, primary site of brain   |
| C783 Neoplasm, malignant, secondary site of lung and other respiratory organs                             |
| C788 Neoplasm, malignant, secondary site of liver, intrahepatic bile duct and other digestive organs      |
| C793 Neoplasm, malignant, secondary site of brain and cerebral meninges                                   |
| C799 Neoplasm, malignant, secondary site, other or unknown site   |
| C809 Neoplasm, malignant, primary site, other or unknown site   |
| C859 Neoplasm, malignant, non-Hodgkin lymphoma  |
| C9000 Neoplasm, malignant, multiple myeloma without mention of remission (includes plasma cell neoplasms) |
| C9290 Neoplasm, malignant, myeloid leukaemia  |
| C9590 Neoplasm, malignant, leukaemia, unspecified cell type   |
| C969 Neoplasm, malignant, lymphoid, haematopoietic and related tissue, other                              |
| D099 Carcinoma in situ, any site  |
| D179 Neoplasm, benign lipoma (lipomatous neoplasm)  |
| D259 Neoplasm, benign lipoma (lipomatous neoplasm)  |
| D309 Neoplasm, benign of urinary system   |
| D369 Neoplasm, benign, of other site  |
| D379 Neoplasm, unknown whether malignant or benign of digestive organ                                     |
| D386 Neoplasm, unknown whether malignant or benign of respiratory organ                                   |
| D439 Neoplasm, unknown whether malignant or benign of brain or central nervous system                     |
| D489 Neoplasm, unknown whether malignant or benign of other or unknown site                               |
| <b>T60 Septicaemia</b>  |
| A399 Meningococcal infection, invasive  |
| A419 Sepsis (except with notifiable agent)  |
| R572 Severe sepsis or septic shock (infectious or noninfectious origin)                                   |
| <b>T62 Fever of unknown origin</b>  |
| R509 Fever  |
| <b>T63 Viral illnesses</b>  |

|   |
|---|
| A89 Viral infection of central nervous system, other  |
| A979 Dengue fever   |
| B000 Eczema herpeticum (Kaposi's varicelliform eruption)                                      |
| B001 Herpesviral simplex vesicular dermatitis   |
| B002 Herpesviral simplex gingivostomatitis or pharyngotonsillitis                             |
| B005 Herpesviral simplex ocular disease   |
| B009 Herpesviral simplex infection (except sexually transmitted HSV-2)                        |
| B019 Varicella zoster (chickenpox)  |
| B029 Herpes zoster (shingles)   |
| B03 Smallpox  |
| B059 Measles  |
| B069 Measles, German (rubella) or congenital rubella  |
| B07 Viral warts (except anogenital)   |
| B081 Molluscum contagiosum  |
| B082 Roseola infantum (exanthema subitum, sixth disease)                                      |
| B083 Erythema infectiosum (fifth disease)   |
| B084 Enteroviral vesicular stomatitis with exanthem (hand, foot and mouth disease HFMD)       |
| B09 Infection of skin, viral, with skin or mucous membrane lesions, other                     |
| B159 Hepatitis A, acute   |
| B161 Hepatitis D, acute (acute hepatitis B with delta agent)                                  |
| B169 Hepatitis B, acute (without delta agent)   |
| B171 Hepatitis C, acute   |
| B172 Hepatitis E, acute   |
| B24 Human immunodeficiency virus (HIV) infection or acquired immunodeficiency syndrome (AIDS) |
| B269 Mumps  |
| B279 Infectious mononucleosis (glandular fever)   |
| B331 Ross River virus infection   |
| B338 Viral infection, specified virus   |
| B349 Viral infection, unspecified virus, other  |
| <b>T64 Infectious and parasitic diseases, other</b>   |
| A010 Typhoid fever  |
| A014 Paratyphoid fever  |
| A029 Salmonellosis (Salmonella infection except Salmonella typhi or Salmonella Paratyphi)     |
| A209 Plague   |
| A219 Tularaemia   |
| A229 Anthrax  |
| A239 Brucellosis  |
| A279 Leptospirosis  |
| A289 Bacterial zoonotic diseases, other   |
| A309 Leprosy  |
| A329 Listeriosis  |
| A35 Tetanus   |

|  |
|--|
| A369 Diphtheria  |
| A38 Scarletina (scarlet fever)   |
| A4900 Staphylococcal infection (except Methicillin-resistant)                              |
| A4901 Staphylococcus aureus infection, Methicillin-resistant                               |
| A492 Haemophilus influenzae infection (except Avian flu)                                   |
| A499 Bacterial infection, other  |
| A509 Syphilis, congenital  |
| A539 Syphilis, primary, secondary, early latent or latent                                  |
| A549 Gonococcal infection  |
| A568 Chlamydial infection, sexually transmitted  |
| A58 Donovanosis (granuloma inguinale)  |
| A600 Herpesviral simplex (HSV) infection of genitalia or urogenital tract (genital herpes) |
| A6300 Human papillomavirus (HPV) infection of genitalia (anogenital warts)                 |
| A64 Sexually transmitted disease (STD), other  |
| A70 Chlamydia psittaci infection (ornithosis and psittacosis)                              |
| A749 Chlamydial infection, other   |
| A78 Q fever  |
| A799 Rickettsiosis, other  |
| A829 Rabies or bat lyssavirus  |
| A920 Chikungunya fever   |
| A923 West Nile (Kunjin) fever  |
| A928 Mosquito-borne viral fevers (Barmah forest fever)                                     |
| A929 Flavivirus (Zika virus)   |
| A94 Arthropod-borne, non-notifiable viral fever, other                                     |
| A959 Yellow fever  |
| A962 Lassa fever, quarantinable  |
| A980 Crimean-Congo haemorrhagic fever, quarantinable                                       |
| A983 Marburg virus, quarantinable  |
| A984 Ebola virus, quarantinable  |
| A99 Haemorrhagic fever, viral, non-quarantinable   |
| B49 Mycosis (fungus) related infections, other   |
| B54 Malaria  |
| B602 Naegleriasis  |
| B89 Parasitic disease, other (includes head lice)  |
| B99 Infectious disease, other  |
| Z209 Contact or exposure to communicable disease (includes suspected exposure)             |
| <b>U62 Psychosis</b>   |
| F209 Schizophrenia   |
| F229 Persistent delusional disorder and paranoia (except in schizophrenia)                 |
| F2390 Psychosis, acute, transient  |
| F259 Schizoaffective disorder, with or without psychotic episode                           |
| F29 Psychosis, other   |

| <b>U69 Mental and behavioural disorders, other</b>  |
|---|
| F309 Manic episode, single  |
| F319 Bipolar affective disorder   |
| F3290 Depressive episode, single (except postnatal depression)                                      |
| F339 Depressive disorder, recurrent (except in bipolar or postnatal depression)                     |
| F39 Mood affective disorder, other  |
| F410 Panic disorder   |
| F412 Anxiety disorder with mixed depressive disorder  |
| F419 Anxiety disorder, generalised or phobic  |
| F430 Stress reaction, acute, transient  |
| F431 Post traumatic stress disorder (PTSD)  |
| F432 Adjustment disorders, other  |
| F439 Stress reaction, other   |
| F449 Dissociative or conversion disorder  |
| F459 Somatoform disorder  |
| F489 Neurotic disorders, other  |
| F500 Anorexia nervosa   |
| F509 Eating disorders, bulimia, other   |
| F539 Post natal depression and other mental disorders in puerperium                                 |
| F609 Personality disorder, specified  |
| F69 Behavioural disorder, adult   |
| F89 Neurodevelopment disorders (includes autism, Asperger's)  |
| F919 Conduct disorder, child or adolescent onset  |
| F939 Emotional disorder, child or adolescent onset  |
| F989 Behavioural and emotional disorders, child or adolescent onset, other or mixed disorders       |
| F99 Mental disorders or mental illness, other   |
| R443 Hallucinations (except with underlying mental or behavioural disorder)                         |
| R4581 Suicidal ideation (except with underlying mental or behavioural disorder)                     |
| R4589 Attempted self-injury (harm) or symptoms involving emotional state, other                     |
| <b>V69 Alcohol and/ or drug related mental and behavioural disorders</b>                            |
| F100 Intoxication from alcohol, acute (except poisoning)  |
| F103 Withdrawal from alcohol (except poisoning)   |
| F109 Mental and behavioural disorders due to alcohol (except intoxication, withdrawal or poisoning) |
| F119 Mental and behavioural disorders due to opioids  |
| F129 Mental and behavioural disorders due to cannabinoids   |
| F1390 Mental and behavioural disorders due to sedatives or hypnotics                                |
| F149 Mental and behavioural disorders due to cocaine  |
| F1590 Mental and behavioural disorders due to other stimulants (includes caffeine)                  |
| F1690 Mental and behavioural disorders due to hallucinogens   |
| F179 Mental and behavioural disorders due to tobacco  |
| F189 Mental and behavioural disorders due to volatile solvents                                      |
| F190 Intoxication from multiple psychoactive substance use (except poisoning)                       |

|   |
|---|
| F193 Withdrawal from multiple psychoactive substance use (except poisoning)   |
| F199 Mental and behavioural disorders due to multiple psychoactive substance use (except acute intoxication, withdrawal or poisoning) |
| F559 Harmful use of non-dependence producing substances   |
| <b>X61 Allergic reactions</b>   |
| T780 Anaphylaxis due to adverse food reaction   |
| T781 Allergy to food (except anaphylaxis)   |
| T782 Anaphylaxis, other (except with envenomation, drug or noxious poisoning)   |
| T783 Oedema, skin, subcutaneous tissue, muscle  |
| T784 Allergy, other (except anaphylaxis)  |
| <b>X62 Poisoning due to drugs and other substances</b>  |
| T369 Poisoning or exposure to antibiotics   |
| T379 Poisoning or exposure to anti-infective and antiparasitic drugs  |
| T389 Poisoning or exposure to hormone antagonists   |
| T390 Poisoning or exposure to salicylates   |
| T391 Poisoning or exposure to paracetamol (4-Aminophenol derivatives)   |
| T399 Poisoning or exposure to other nonopioid analgesic, antipyretic and antirheumatic  |
| T401 Poisoning or exposure to heroin  |
| T402 Poisoning or exposure to codeine or morphine, or other opioids   |
| T409 Poisoning or exposure to psychodysleptics (hallucinogens)  |
| T4121 Poisoning or exposure to gamma hydroxybutyrate (GHB)  |
| T4122 Poisoning or exposure to ketamine   |
| T414 Poisoning or exposure to other anaesthetic   |
| T423 Poisoning or exposure to barbiturates  |
| T424 Poisoning or exposure to benzodiazepines   |
| T427 Poisoning or exposure to other antiepileptic and sedative-hypnotic drugs   |
| T430 Poisoning or exposure to tricyclic and tetracyclic antidepressants (TCA)   |
| T432 Poisoning or exposure to other antidepressants   |
| T439 Poisoning or exposure to other psychotropic drug   |
| T449 Poisoning or exposure to drugs affecting the autonomic nervous system  |
| T451 Poisoning or exposure to immunosuppressive and antineoplastic drugs  |
| T454 Poisoning or exposure to iron  |
| T455 Poisoning or exposure to anticoagulants  |
| T459 Poisoning or exposure to primarily systemic and haematological agent, antiallergic drugs, vitamins, or enzymes                   |
| T469 Poisoning or exposure to agent primarily affecting the cardiovascular system (CVS)   |
| T479 Poisoning or exposure to agent primarily affecting the gastrointestinal system (GIT)   |
| T487 Poisoning or exposure to agent primarily affecting the smooth and skeletal muscles or respiratory system                         |
| T499 Poisoning or exposure to topical agent   |
| T509 Poisoning or exposure to other drugs, medicaments and biological substances  |
| T510 Poisoning or exposure to ethanol (ethyl alcohol)   |
| T519 Poisoning or exposure to other alcohol   |
| T529 Poisoning or exposure to organic solvent   |
| T58 Poisoning or exposure to carbon monoxide  |

|  |
|--|
| T599 Poisoning or exposure to other gases, fumes and vapours (includes smoke inhalation)   |
| T629 Poisoning or exposure to noxious substance eaten as food  |
| T630 Poisoning or exposure to snake venom, land and sea snakes   |
| T633 Poisoning or exposure to spider venom   |
| T634 Poisoning or exposure to other arthropods   |
| T636 Poisoning or exposure to marine animals   |
| T639 Poisoning or exposure to other venomous animal  |
| T659 Poisoning or exposure to other non-medical substances   |
| <b>X64 Abuse and neglect</b>   |
| T741 Abuse, physical, child or adult (except sexual assault)   |
| T742 Abuse, sexual (assault, rape), child or adult   |
| T743 Abuse, psychological, child or adult  |
| T749 Abuse, maltreatment, neglect or abandonment, child or adult   |
| <b>Y62 Other burns</b>   |
| T200 Burn of head or neck (except isolated burn to eye and adnexa), unspecified thickness  |
| T201 Burn of head or neck (except isolated burn to eye and adnexa), superficial (erythema, sunburn, first degree)                            |
| T202 Burn of head or neck (except isolated burn to eye and adnexa), partial or deep partial thickness (sunburn with blisters, second degree) |
| T203 Burn of head or neck (except isolated burn to eye and adnexa), full thickness (third degree, fourth degree, complex)                    |
| T2109 Burn of trunk, unspecified thickness   |
| T2119 Burn of trunk, superficial (erythema, sunburn, first degree)   |
| T2129 Burn of trunk, partial or deep partial thickness (sunburn with blisters, second degree)  |
| T2139 Burn of trunk, full thickness (third degree, fourth degree, complex)   |
| T2200 Burn of shoulder or upper limb (wrist and hand if affected), unspecified thickness   |
| T2210 Burn of shoulder or upper limb (wrist and hand if affected), superficial (erythema, sunburn, first degree)                             |
| T2220 Burn of shoulder or upper limb (wrist and hand if affected), partial or deep partial thickness (sunburn with blisters, second degree)  |
| T2230 Burn of shoulder or upper limb (wrist and hand if affected), full thickness (third degree, fourth degree, complex)                     |
| T230 Burn of wrist, hand, or fingers, unspecified thickness  |
| T231 Burn of wrist, hand, or fingers, superficial (erythema, sunburn, first degree)  |
| T232 Burn of wrist, hand, or fingers, partial or deep partial thickness (sunburn with blisters, second degree)                               |
| T233 Burn of wrist, hand, or fingers, full thickness (third degree, fourth degree, complex)  |
| T240 Burn of hip or lower limb (ankle and foot if affected), unspecified thickness   |
| T241 Burn of hip or lower limb (ankle and foot if affected), superficial (erythema, sunburn, first degree)                                   |
| T242 Burn of hip or lower limb (ankle and foot if affected), partial or deep partial thickness (sunburn with blisters, second degree)        |
| T243 Burn of hip or lower limb (ankle and foot if affected), full thickness (third degree, fourth degree, complex)                           |
| T250 Burn of ankle or foot, unspecified thickness  |
| T251 Burn of ankle or foot, superficial (erythema, sunburn, first degree)  |
| T252 Burn of ankle or foot, partial or deep partial thickness (sunburn with blisters, second degree)   |
| T253 Burn of ankle or foot, full thickness (third degree, fourth degree, complex)  |
| T264 Burn of eye or adnexa (except with head and neck burns)   |
| T284 Burn of internal organs   |
| T290 Burns of multiple regions, unspecified thickness  |

|  |
|--|
| T291 Burns of multiple regions, superficial (erythema, sunburn, first degree)                            |
| T292 Burns of multiple regions, partial or deep partial thickness (sunburn with blisters, second degree) |
| T293 Burns of multiple regions, full thickness level (third degree, fourth degree, complex)              |
| <b>Z611 Falls risk</b>   |
| R42 Dizziness  |
| <b>Z612 Pain syndrome</b>  |
| R529 Pain, not referable to a site   |
| <b>Z613 Signs and symptoms, other</b>  |
| R18 Ascites  |
| R53 Fatigue and weakness   |
| R571 Shock, hypovolaemic   |
| R579 Shock, other (includes traumatic)   |
| R58 Haemorrhage, other   |
| R609 Oedema  |
| R681 Symptoms of infancy (excessive crying, irritability)  |
| R69 Symptoms without diagnosis, other  |
| R73 Elevated blood glucose level   |
| R799 Abnormal blood test result  |
| R829 Abnormal test result, other   |
| R938 Abnormal findings on diagnostic imaging   |
| <b>Z63 Forensic examination</b>  |
| Z040 Forensic blood-alcohol or blood-drug test   |
| Z049 Forensic examination or observation   |
| <b>Z64 Other factors influencing health status</b>   |
| G470 Insomnia  |
| G479 Sleep disorder  |
| Q899 Malformation, deformation, congenital, other  |
| Q999 Abnormality, chromosomal  |
| R99 Death of unknown cause (includes SIDS and cardiac death)   |
| Z027 Death certificate only  |
| Z099 Follow-up examination, care, other  |
| Z299 Prophylactic measures (includes immunisation)   |
| Z309 Contraceptive management  |
| Z380 Newborn, born in hospital   |
| Z381 Newborn, born outside hospital  |
| Z479 Follow-up examination, care, orthopaedic  |
| Z480 Follow-up examination, care, treatment of wound dressings and sutures                               |
| Z609 Social or psychosocial problems   |
| Z760 Prescription repeat from emergency pharmacy   |